



Trimod HE®

EN

ENGLISH

3



Contents

1	Introduction	6
1.1	Purpose of the manual	6
1.2	Symbols in the manual	6
1.3	Where and how to keep the manual	7
1.4	Update of the manual	7
1.5	Manufacturer's liability and guarantee	7
1.5.1	Guarantee terms	7
1.6	Copyright	8
2	Regulatory and safety requirements	9
2.1	General notes	9
2.2	Definitions of "Skilled Technician" and "Operator"	9
2.2.1	Skilled Technician	9
2.2.2	Operator	9
2.3	Personal Protective Equipment	10
2.4	Hazard signs in the workplace	10
2.5	Signs on the equipment	10
2.6	General warnings	11
2.7	How to proceed in an emergency	13
2.7.1	First-aid procedures	13
2.7.2	Fire procedures	13
3	Unpacking and positioning	14
3.1	Visual check	14
3.1.1	Equipment and supplied accessories check	14
3.2	Unpacking	14
3.3	Check of the content	14
3.4	Movement	15
3.5	Positioning constraints	15
3.6	Final operations	15
4	Installation	16
4.1	Safety regulations	16
4.2	Electric connections	16
4.2.1	Safety warnings	16
4.2.2	Preliminary operations	17
4.2.3	Wiring	17
4.2.4	Earthing	18
4.2.5	Protective devices	18
4.2.6	Backfeed protection	18
4.2.7	External battery cabinets installation	23
4.2.8	Mains connection	29
4.2.9	Bypass input line connection (if separate)	30
4.2.10	Output line connection	30

Contents

4.3 Wiring diagrams	31
4.3.1 Factory configuration: THREE PHASE input – THREE PHASE output with common bypass input line	31
4.3.2 THREE PHASE input - THREE PHASE output connection with separate bypass input line	33
4.3.3 THREE PHASE input – SINGLE PHASE output connection	34
4.3.4 SINGLE PHASE input - SINGLE PHASE output connection	36
4.3.5 SINGLE PHASE input - THREE PHASE 120° output connection	38
4.3.6 SINGLE PHASE input - THREE INDEPENDENT PHASE output connection	39
4.3.7 Installation of the connection jumpers	40
4.3.8 ARBC (Auxiliary Remote Bypass Contact)	42
4.4 Insertion of power modules and battery drawers	42
4.5 Communication devices	43
4.5.1 RS232 serial ports	43
4.5.2 Relay interface	44
4.5.3 Emergency Power Off (EPO)	44
4.5.4 Logic level interface	45
4.5.5 Network card (SNMP) slot	46
5 Configuration and Start-up	47
5.1 Introduction	47
5.2 Input configuration	47
5.3 Output configuration	47
5.4 Pre-start-up checks	47
5.5 Start-up procedure	48
5.6 ECO MODE setup	50
6 Maintenance	51
6.1 Introduction	51
6.2 Preventive maintenance	51
6.3 Periodical checks	51
6.4 Ordinary maintenance	51
6.4.1 Power module hot-swap replacement or inclusion of new modules	51
6.4.2 Maintenance procedure for the UPS in maintenance bypass mode	54
6.4.3 Maintenance procedure with UPS off	56
6.5 Battery drawers requirements	56
6.5.1 Installation/replacement of battery drawers with UPS in normal mode	57
6.5.2 Installation/replacement of battery drawers with UPS in maintenance manual bypass	57
6.6 Extraordinary maintenance	57

7 Warehousing	58
8.1 UPS	58
8.2 Batteries	58
8 Dismantling	59
8.1 Battery disposal	59
8.2 UPS dismantling	59
8.3 Electronic component dismantling	59
9 Technical data	60
10 Tables	67
11 Wiring diagrams	71
11.1 Block diagram of interconnections and distributions of the UPS cabinet	71

1. Introduction



CAUTION

The instructions in this manual are intended for a **SKILLED TECHNICIAN** (paragraph 2.2.1).

1.1 Purpose of the manual

The purpose of this manual is to provide the skilled technician (see paragraph 2.2.1) with instructions for safely installing the TRIMOD HE unit, also called "UPS" or "equipment" in the rest of the manual, and carry out ordinary maintenance procedures.

Extraordinary maintenance operations are not dealt with in this manual because they are the sole preserve of LEGRAND's Technical Support Service.

The reading of this manual is essential but does not substitute the skill of the technician who must have received adequate preliminary training.

The intended use and configurations envisaged for the equipment and shown in this manual are the only ones allowed by the Manufacturer.

Any other use or configuration must be previously agreed with the Manufacturer in writing and, in this case, the written agreement will be attached to the manuals.

This manual also makes reference to laws, directives and standards that the skilled technician is required to be aware of and consult.

The original text of this publication, drafted in Italian, is the only reference for the resolution of disputes of interpretation linked to translations into other languages.

1.2 Symbols in the manual

Some operations are shown in graphic symbols that draw the attention of the reader to the danger or the importance they imply:



DANGER

This indication shows a danger entailing a high degree of risk that, if not avoided, will lead to death or serious injury or considerable damage to the equipment and the things around it.



WARNING

This indication shows a danger entailing a medium degree of risk that, if not avoided, could lead to death or serious injury or considerable damage to the equipment and the things around it.



CAUTION

This indication shows a danger entailing a low level of risk that, if not avoided, could lead to minor or moderate injury or material damage to the equipment and the things around it.

INDICATION

This symbol indicates important information which should be read carefully.

1.3 Where and how to keep the manual

This manual must be kept in a safe, dry place and must always be available for consultation exclusively by the skilled technician.

It is recommended to make a copy of it and file it away.

If information is exchanged with the Manufacturer or the authorised assistance personnel, it is essential to refer to the equipment's rating plate data and serial number.

INDICATION

The supplied manuals are an integral part of the equipment and must therefore be kept for their entire lifetime.

In case of need (for example in case of damage that even partially compromise the consultation) the skilled technician is required to get a new copy from the Manufacturer, quoting the publication code on the cover.

1.4 Update of the manual

The manual reflects the state of the art when the equipment was put onto the market. The publication conforms with the standards current on that date. The manual cannot be considered inadequate when new standards come into force or modifications are made to the equipment.

Any addition to the manual that the Manufacturer considers appropriate to send to the users, must be kept together with the manual of which they will become an integral part.

The updated version of the manual is available on the Internet at <http://www.ups.legrand.com>

1.5 Manufacturer's liability and guarantee

The skilled technician and the operator shall scrupulously comply with the precautions indicated in the manuals.

They must:

- always work within the operating limits of the equipment;
- always carry out constant and careful maintenance through a skilled technician who complies with all the procedures indicated in the installation and maintenance manual.

The Manufacturer declines all indirect or direct responsibility arising from:

- assembly and cabling made by personnel not qualified and authorized by LEGRAND and not fully qualified according to national standards to work on equipment presenting electrical hazards;
- assembly and cabling made without using safety equipment and tools required by national safety standards;
- failure to observe the installation, maintenance instructions and use of the equipment which differs from the specifications in the user manual;
- use by personnel who have not read and thoroughly understood the content of the user manual;
- use that does not comply with the specific standards used in the country where the equipment is installed;
- modifications made to the equipment, software, functioning logic unless they have been authorised by the Manufacturer in writing;
- repairs that have not been authorised by the LEGRAND Technical Support Service;
- damage caused intentionally, through negligence, by acts of God, natural phenomena, fire or liquid infiltration;
- damage caused by the use of batteries and protections not specified in the manuals;
- damage caused by improper unloading and transportation after delivery of the equipment;
- accidents caused by a wrong assembly of the safety protections or due to the lack of application of the safety labels specified in the installation manual.

Transfer of the equipment to others also requires the handing over of all the manuals. Failure to hand over the manuals shall automatically nullify any right of the buyer, including the terms of the guarantee where applicable.

If the equipment is sold to another party in a country where a different language is spoken, the original owner shall be responsible for providing a faithful translation of the manuals in the language of the country where the equipment will be used.

1.5.1 Guarantee terms

The terms of the guarantee may vary depending on the country where the UPS is sold. Check the validity and duration with LEGRAND's local sale representative.

If there should be a fault in the equipment, contact the LEGRAND Technical Support Service which will provide all the instructions on what to do.

Do not send anything back without LEGRAND's prior authorization.

1. Introduction

The guarantee becomes void if the UPS has not been brought into service by a properly trained skilled technician (see paragraph 2.2.1).

If during the guarantee period the equipment does not conform with the characteristics and performance laid down in this manual, LEGRAND at its discretion will repair or replace the UPS and relative parts.
All the repaired or replaced parts will remain LEGRAND's property.

LEGRAND is not responsible for costs such as:

- losses of profits or earnings;
- losses of equipment, data or software;
- claims by third parties;
- any damage to persons or things due to improper use, unauthorized technical alterations or modifications;
- any damage to persons or things due to installations where the full compliance with the standard regulating the specific usage applications have not been guaranteed.

1.6 Copyright

The information contained in this manual cannot be disclosed to any third party. Any partial or total duplication of the manual by photocopying or other systems, including electronic scanning, which is not authorised in writing by the Manufacturer, violates copyright conditions and may lead to prosecution.

LEGRAND reserves the copyright of this publication and prohibits its reproduction wholly or in part without previous written authorisation.

2. Regulatory and safety requirements



DANGER

Before carrying out any operation on the equipment, it is necessary to read the entire manual carefully, especially this chapter.

Look after this manual carefully and consult it repeatedly during installation and maintenance by a skilled technician.

2.1 General notes

The equipment has been made for the applications given in the manuals. It may not be used for purposes other than those for which it has been designed, or differently from those specified.

The various operations must be carried out according to the criteria and the chronology described in this manual.

2.2 Definitions of "Skilled Technician" and "Operator"

2.2.1 Skilled Technician

The professional figure who will carry out the installation, start up and ordinary maintenance is called "Skilled Technician". This definition refers to people who have specific technical qualification and are aware of the method of installing, assembling, repairing, commissioning and safe use of the equipment.

In addition to the requirements listed in the section below for a general operator, the Skilled Technician must be qualified in accordance with the safety regulations in force in the country of installation on the measures to implement when working in presence of hazardous voltage. He must also use the Personal Protective Equipment required by the safety regulations in force at the country of installation for all the activities indicated in the installation and maintenance manual (see the examples listed at paragraph 2.3).



WARNING

The safety manager is responsible for protection and company risks prevention according to what is indicated in the European directives 2007/30/EC and 89/391/EEC regarding safety in the workplace.

The safety manager must ensure that all people working on the equipment have received the instructions included in the manuals with particular reference to those contained in this chapter.

2.2.2 Operator

The figure assigned to the equipment for normal use is called "Operator".

This definition refers to people who know how to operate the equipment as described in the user manual and have the following requisites:

1. technical education, which enables them to operate according to safety standards in relation to the dangers linked to the presence of electric voltage;
2. training on the use of personal protective equipment and basic first aid interventions.

The company safety manager, in choosing the person (operator) who uses the equipment, must consider:

- the person's work fitness according to the laws in force;
- the physical aspect (not disabled in any way);
- the psychological aspect (mental stability, sense of responsibility);
- the educational background, training and experience;
- the knowledge of the standards, regulations and measures for accident prevention.

He should also impart training in such a way as to provide thorough knowledge of the equipment and its component parts.

The operator shall consult the user manual at any time. He shall also follow the requirements provided to achieve maximum safety for himself and others during all operating phases.

Some typical activities the operator is expected to carry out are:

- the use of the equipment in its normal functioning state and the restore of the functioning after it shuts down;
- the adoption of the necessary provisions for maintaining the quality performance of the UPS;
- the cleaning of the equipment;
- cooperation with personnel responsible for ordinary maintenance activities (skilled technicians).

2. Regulatory and safety requirements

2.3 Personal Protective Equipment



The UPS poses a considerable risk of electric shock and a high short circuit current. During use and maintenance operations, it is forbidden to operate without the equipments listed in this paragraph.

People responsible for operating this equipment and/or passing close to it must not wear garments with flowing sleeves, nor laces, belts, bracelets or other metal pieces that might cause a danger.

The following signs sum up the minimum Personal Protective Equipment to wear at all times. Additional requirements may be provided for by the safety regulations in force in the country of installation.



Anti-accident and no-spark shoes with rubber sole and reinforced toe



Safety gloves for protection from mechanical risks



Dielectric gloves for protection from dangerous voltages



Protective clothing for electrical work



Electrical protection helmet and visor



1000 V Insulated tools

2.4 Hazard signs in the workplace

The following signs must be exhibited at all points of access to the room where the equipment is installed:



Electric current
This sign indicates the presence of electrical live parts.



Emergency interventions
Do not use water to quench fires but only the extinguishers specifically designed for putting out fires in electrical equipment.



No smoking
This sign indicates that smoking is not allowed in the area.

2.5 Signs on the equipment

Displayed on the UPS are explanatory plates that can vary depending on the country the equipment is intended for and constructional standards applied.

Safety labels are in English. A set of labels is supplied in several languages. During the installation, it is the responsibility of the skilled technician to replace the labels in English with those in the most understandable language in the country in which the equipment is installed.

Make sure the instructions are adhered to. It is strictly prohibited to remove these plates and to work in a way that differs from what is written there.

The plates must always be clearly read and they must be cleaned periodically.

If a plate deteriorates and/or it is no longer legible, even partially, the Manufacturer must be contacted for another one in order to replace it.

 **CAUTION**

The plates must not be removed or covered. No other plates may be affixed to the equipment without the Manufacturer's prior written authorisation.

 **WARNING**

Potential risks can be drastically reduced by wearing the Personal Protective Equipment listed in this chapter. These protections are indispensable. Always operate with due care around dangerous areas marked by the appropriate warning signs on the equipment.

2.6 General warnings

 **DANGER**

The UPS works with dangerous voltages. Only SKILLED TECHNICIANS must perform the installation and ordinary maintenance operations. No part of the equipment can be repaired by the operator. Extraordinary maintenance operations must be carried out by LEGRAND Technical Support Service personnel.

 **DANGER**

Before beginning any installation and/or maintenance operation, make sure that all the DC and AC power sources are disconnected.

The UPS must be installed with an earth connection to avoid high leakage currents. First connect the earthing cable. Check during each installation and/or maintenance operation the continuity of the earthing system.

 **DANGER**

The UPS is powered by its own DC energy source (batteries). The output terminals may have a dangerous voltage even if the UPS is not connected to the AC power network.

The DC power source could comprise multiple battery drawers in parallel and/or external battery cabinets. Disconnect all battery drawers and external battery cabinets before performing any installation and/or maintenance operation.

 **WARNING**

A battery can present a risk of electrical shock and high short circuit current. The following precautions should be observed when working on batteries:

- a) remove watches, rings or other metal objects;
- b) use tools with insulated handles;
- c) wear rubber gloves and boots;
- d) do not lay tools or metal parts on top of batteries;
- e) disconnect the charging source prior to connecting or disconnecting battery terminals;
- f) determine if battery is inadvertently grounded. If inadvertently grounded, remove source from ground. Contact with any part of a grounded battery can result in electrical shock. The likelihood of such shock can be reduced if such grounds are removed during installation and maintenance (applicable to equipment and remote battery supplies not having a grounded supply circuit);
- g) never leave live cables without an insulated protection.

Do not dispose of batteries in a fire. The batteries may explode.

Do not open or mutilate batteries. Released electrolyte is harmful to the skin and eyes. It may be toxic. The batteries installed inside the cabinet must be disposed of correctly. For the disposal requirements refer to local laws and relevant standards.

2. Regulatory and safety requirements

 **CAUTION**

The UPS functions with TT and TN systems. It has a pass-through neutral architecture: the status of the output neutral is the same as the input neutral.

When a load needs a different neutral status from the input status, it is necessary to place downstream of the equipment a suitably scaled isolation transformer protected in compliance with the standards in force.

For electromedical applications which require the medical IT system, it is necessary to have an insulation board downstream the UPS that ensures compliance with the regulations in force for this type of application.

 **CAUTION**

Do not open the battery fuse holders while the UPS is powering the loads in battery mode.

 **WARNING**

To reduce the risk of fire or electric shock, the UPS must work in clean and indoor environments with controlled temperature and humidity. It must be kept away from inflammable liquids and corrosive substances. The room temperature must not be above +40°C (+104°F) and the relative humidity must be a maximum of 95% not condensing.

 **CAUTION**

Trimod HE 10 is a category C2 UPS product. In a residential environment, this product may cause radio interference, in which case the user may be required to take additional measures.

All the other Trimod HE models are products for commercial and industrial application in the second environment - installation restrictions or additional measures may be needed to prevent disturbances.

The skilled technician must also:

- pass with a double turn, the cables connected to the backfeed terminals to a Fair-Rite toroid code 0431176451 made with T31 material, installed as close as possible to the clamps;
- pass the input cables through three EPCOS TDK toroids code B64290L699X35 made with T35 material;
- pass the output cables through two EPCOS TDK toroids code B64290L699X35 made with T35 material;

 **CAUTION**

- The equipment must be maintained and used according to the instructions written in the manuals.
- The departmental manager must instruct the operating and maintenance personnel on the safe use and maintenance of the equipment.
- Only specifically-trained, highly skilled personnel are allowed access to the equipment in order to perform maintenance. While the maintenance operation is being carried out, signs saying "Maintenance work in progress" must be affixed in the department in such a way that they can be easily seen from any access area.
- The connection of the equipment (and of any accessory devices) must always be perfectly grounded to discharge short-circuit currents and electrostatic voltages. The input voltage must correspond with the value shown on the rating plate. Current adapters must not be used under any circumstances. Pay attention to polarity when connecting.
- Any intervention on the equipment must be done only after it has been disconnected from the power supply network by means of a switch disconnecter and must be locked with an appropriate padlock.
- The UPS must not be turned on if liquid is leaking from the batteries.
- The equipment used for any maintenance operations (pliers, screwdrivers etc.) must be electrically insulated.
- Depositing flammable material near the equipment is strictly forbidden. The equipment should always be locked, and only specifically trained personnel are allowed access to it.
- Do not disable any safety notification or warning device and do not ignore any alarm or warning message no matter whether they are generated automatically or represented by plates fixed to the equipment.
- Do not run the equipment with fixed protections not installed (panels etc.).
- In case of breaking, buckling or malfunctioning of the equipment or parts of it, repair or replace immediately.
- For no reason can the structure of the equipment, the devices mounted on it, the operation sequence etc, be modified, manipulated or tampered with in any way, without prior consultation with the Manufacturer.
- When replacing fuses, only use ones of the same type.
- The replacement of the batteries is an operation intended to be carried out by a skilled technician.

-
- Keep a register in which to enter the date, time, type, performer's name and any other useful information about each and any routine and extraordinary maintenance operation.
 - Do not use oils or chemical products for cleaning because they could scratch, corrode or damage certain parts of the equipment.
 - The equipment and workplace must be kept completely clean.
 - Upon completion of the maintenance operations, before connecting the power supply, carefully check that no tools and/or material of any kind have been left next to the equipment.

**CAUTION**

The skilled technician must not leave at the disposal of the operator:

- the keys for opening the UPS door;
- the installation and maintenance manual;
- the additional quickstart sheet.

2.7 How to proceed in an emergency

The following information are general.

For the specific interventions consult the regulations in force in the country where the equipment is installed.

2.7.1 First-aid procedures

When administering first aid, adhere to the company rules and the usual procedures.

2.7.2 Fire procedures

Do not use water to quench fires but just the extinguishers specifically designed for putting out fires on electrical equipments.

3. Unpacking and positioning

3.1 Visual check

On delivery of the UPS, carefully inspect the packaging and the product for any damage that might have occurred during transport. Check there is no damage to the indicator on the outer label reading "Shock Watch".

If there is possible or ascertained damaged immediately inform:

- the transporter;
- the LEGRAND Technical Support Service.

Check the equipment corresponds with the material indicated in the delivery documentation.

Follow the instructions in Chapter 8 when storing the UPS.

3.1.1 Equipment and supplied accessories check

The equipment and the relative supplied accessories must be a perfect state of repair.

Check that:

- the shipping data (address of the recipient, no. of packages, order no, etc.) correspond to what is contained in the delivery documentation;
- the technical rating plate data on the label applied to the UPS correspond with the material purchased, described in the delivery documentation;
- the documentation accompanying the equipment includes the installation manual and the user manual.

Should any of these be different from what they should be, immediately inform the LEGRAND Technical Support Service before commissioning the equipment.

3.2 Unpacking

To remove the packaging material, comply with the icons on the outside of the box and observe the following procedure:

1. cut the wrapping material and open the plastic packaging safety holds;
2. open the top of the box;
3. remove the upper protection;
4. remove the four protective corners;
5. remove the packaging container pulling it upwards;
6. remove the pallet and the front/rear bracket from the UPS by undoing the four fixing screws present;
7. examine the equipment for any damage. Immediately inform the shipper and the supplier in the case of apparent damage.

Keep the packaging material for any future shipment.

The package can be fully recycled.

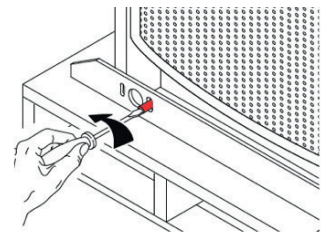

3.3 Check of the content

The content of the supply is subject to thorough checking before the shipment; nonetheless it is always advisable to check that it is complete and in order on receiving the material.

The following list is general:

- 1 Trimod HE UPS;
- 1 envelope of accessories containing washers for the contact with the earthing, set of screws for fitting the panels, two eight-pole terminal strips, a serial cable and fuses (the latter are only included on models with internal batteries);
- 1 envelope of accessories containing one or more EC15 connectors according to the model and connecting jumpers for the terminal strip (ONLY for Trimod HE 10, 15, 20 and 30 TM);
- 1 front closing panel;
- 2 base strips for side closing;
- user manual;
- acceptance report;
- quickstart and installation manual.

Should there be defects and/or missing material, immediately inform the LEGRAND Technical Support Service before commissioning the equipment.



CAUTION

The quickstart and the installation manual must be used and consulted by SKILLED TECHNICIANS only.

INDICATION

When purchasing empty cabinets, the power modules and any battery drawers to be installed must be purchased separately.

3.4 Movement



WARNING

Move the UPS very carefully, lifting it as little as possible and avoiding dangerous swings or falls. The equipment must always be handled by trained and instructed personnel equipped with the Personal Protective Equipment illustrated in chapter 2.

The Trimod HE UPS has wheels at the back of the cabinet. Before installation and while it is still empty, it can be moved by hand by at least two people.

For any lifting, use a forklift or a transpallet with an adequate carrying capacity, placing the forks in the wooden base and making sure they come out the other side by at least twenty centimetres.



WARNING

Do not move the UPS after installation or following the insertion of power modules and any battery drawers.

3.5 Positioning constraints

Minimum recommended distances for the UPS
X=100 mm / Y=200 mm

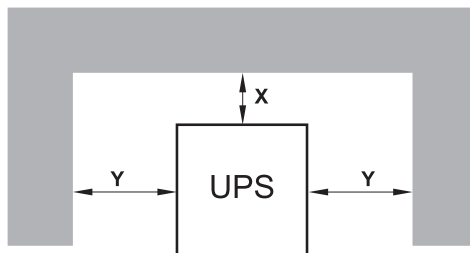

Recommended minimum distances
UPS Trimod HE®
+ Trimod HE®
BATTERY
X=100 mm / Y=200 mm

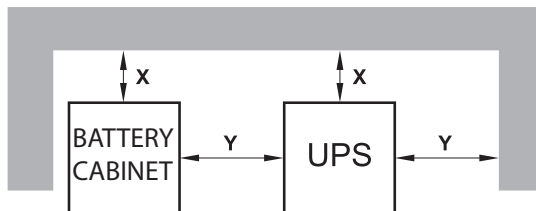

The UPS must be positioned respecting the following conditions:

- temperature and humidity must be within permitted limits;
- fire regulations must be respected;
- the wiring must be simply made;
- front and rear accessibility must be available for assistance or periodic servicing;
- the cooling flow of air must be guaranteed;
- the air conditioning system must be adequately scaled;
- dust or corrosive/explosive gasses must be absent;
- the premises must be free of vibration;
- the rear and side space must be enough to guarantee an adequate circulation of air for cooling;
- the support surface must be scaled in for the carrying capacity necessary to support the equipment.

To safeguard the batteries as well as possible it is necessary to bear in mind that their average lifetime is strongly influenced by the operating room temperature.

Position the UPS in an environment with a temperature range between +20°C (+68°F) and +25°C (+77°F) to guarantee the optimum life of the batteries.

Before proceeding with the installation operations, make sure that there is enough lighting to clearly see every detail. Provide artificial lighting if the natural lighting does not satisfy the requirements cited.

In the case of maintenance operations in places that are not sufficiently well lit, portable lighting systems must be used, avoiding shadows that prevent or reduce visibility on the point where you intend to work or on the surrounding areas.

3.6 Final operations

Once the UPS has been properly positioned, fit the two base strips and the front one provided in the accessory kit.

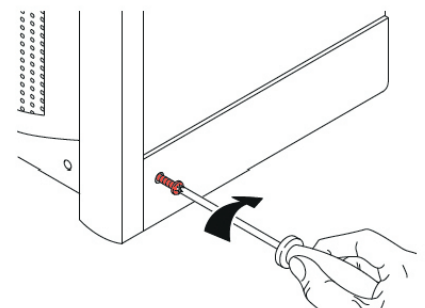

4. Installation



All the UPS installation operations must be carried out exclusively by a SKILLED TECHNICIAN.

4.1 Safety regulations



Before carrying out any installation operation you must read and apply the following:

1. The UPS has a high leakage current. It is essential to make the earth connection before connecting the power supply. It is necessary to make sure that the switchgear has a safe connection with the earth circuit and adequate protection as required by the installation standards.
2. The UPS must only be installed in a fixed way with a thermal-magnetic circuit breaker placed upstream of it. Connection to the mains via traditional type plug is not allowed.
3. A circuit to protect from voltage backfeed made as in the diagrams shown in paragraph 4.2.6 must be provided outside the UPS.
4. The switchgear or the disconnecter switch must be installed near the equipment and must be easily accessible.
5. A warning label must be placed on all the mains disconnecter switches installed away from the area of the UPS, for the purpose of reminding the assistance personnel of the fact that the circuit is connected to a UPS. The label must bear the following text (or the equivalent):

Before working on this circuit
- Isolate the Uninterruptible Power System (UPS)
- Then check for the presence of Hazardous Voltage between all terminals including the protective earth.



Risk of Voltage Backfeed

4.2 Electrical connections

The electrical hook-up of the UPS to the switchgear is part of the installation that is not normally performed by the UPS manufacturer; for this reason, the indications that follow are to be considered approximate and it is recommended that the electrical connections are made on the basis of local installation standards.

After removing the UPS from the packaging and positioning it in its definitive place, the skilled technician can begin to make the electrical connections.



The choice of cable type and their cross sections depending on the rated current and their installations must be made as indicated by the installation standards in force and it is a responsibility of the skilled technician. The input current and the output power of the UPS are indicated in chapter 9 and the battery current in table 8 of chapter 10.

INDICATION

Chapter 10 shows the instructions for scaling cables, fuses, automatic and differential breakers.

4.2.1 Safety warnings



Before proceeding with the operations it is necessary to read and apply what is reported below. It is prohibited to proceed with the operations if one or more of the following conditions have not been met:

- Do not carry out the installation in presence of water or humidity.
- Do not open or remove the UPS's panels.
- Check there is no mains voltage on the equipment.
- Check that the loads are off and disconnected from the UPS.
- Check the UPS is off and no voltage is present.
- Check that the battery breakers on the UPS (if present) and all external battery cabinets, if there are any installed, are open.

All the electrical connection operations are carried out on the connection terminal strips inside the UPS. For the Trimod HE 10, 15, 20, 30 TT models, it is necessary to unscrew the distribution drawer locking screws and pull it outward to get at the distribution terminal strip. For the Trimod HE 30 TM, 40, 60 and 80 models, it is necessary to remove both the lower panels to get at the terminal distribution strip.

Outside the drawer there are the fuse breakers (depending on the model), the output switch, the mains input switch, the bypass input switch and the manual maintenance bypass switch.

In the case of Trimod HE 30 TT, the fuse holders have been installed inside the terminal strip.

4.2.2 Preliminary operations

Before connecting the UPS, check that:

- the mains input voltage and frequency correspond with the values indicated in the technical data on the rating plate;
- the earthing has been carried out in compliance with IEC standards or local regulations;
- the electrical system has been fitted with the necessary differential and thermal-magnetic protections upstream of the UPS input.

4.2.3 Wiring

For all the models, it is possible to pass the cables from underneath, through the opening at the base. For the models of Trimod HE from 10 kVA to 60 kVA, it is also possible to pass the cables from the metal plate fixed to the rear panel by means of four screws. In this case it is necessary to lock the cables in place with appropriate cable glands, not supplied, to be inserted in the holes of the plate. The plate has four holes 33 mm in diameter and one hole 16 mm in diameter.

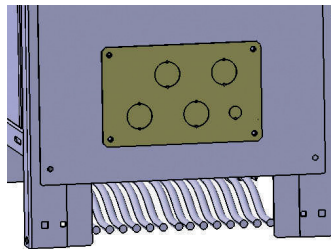

In the case of the Trimod HE 80 kVA, the cables must be passed into the opening at the base. The fastening is done on the appropriate bar by means of clamps and clips present in one of the accessory packs.

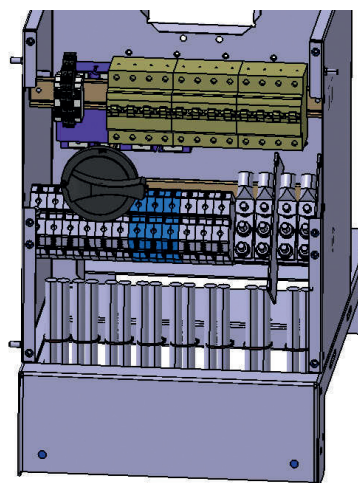

4. Installation

4.2.4 Earthing

Before carrying out any other installation operation, connect the earthing wiring coming from the low voltage switchgear to the earthing terminal on the UPS terminal strip.

In the case of the Trimod HE 80, the earthing cables must be connected via cable lugs in the 8mm threaded holes on the base, as shown in the following image:

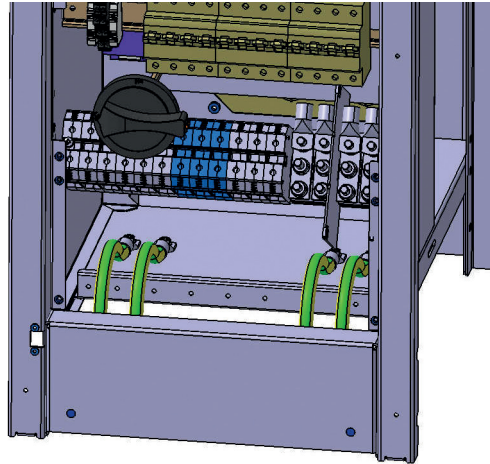

4.2.5 Protective devices

To ensure proper protection from overloads or output short-circuits, it is necessary to use adequate protection at the electrical system level.

Install automatic residual-current and thermal-magnetic breakers upstream of the UPS on the input line and on the bypass line if separate), selected according to the indications in the tables shown in chapter 10.

4.2.6 Backfeed protection

The Trimod HE UPS is fitted with an auxiliary contact for the actuation of the external backfeed protection (protection against power transfer towards the input). This auxiliary contact has been created with a C/NC/NO relay and is available on the the relative tripolar “BACKFEED PROTECTION” terminal on the terminal strip.

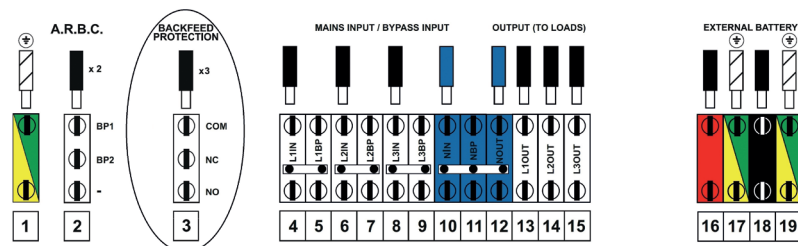

If the UPS detects a voltage backfeed, the relay is energised and changes status, enabling the disconnection of the input lines that must be done externally as indicated in the diagrams shown below.

The relay contacts characteristics are :

- Maximum applicable voltage: 250Vac.
- Maximum applicable current: 5A, $\cos\phi = 1$

INDICATION

If, during operation, the UPS signals that the backfeed protection has been actuated, contact the LEGRAND Technical Support Service.

Connection to a TT or TN-S type distribution network and backfeed circuit connection diagrams with the bypass line in common with the input line

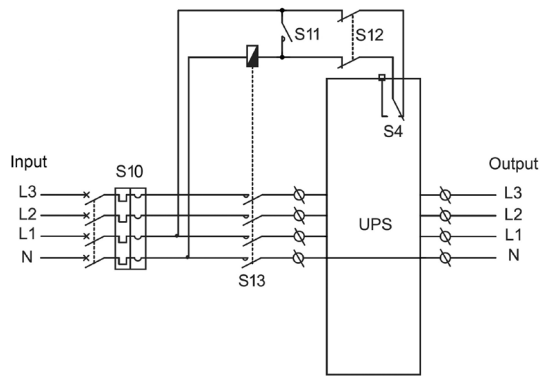

Three phase/Three phase configuration

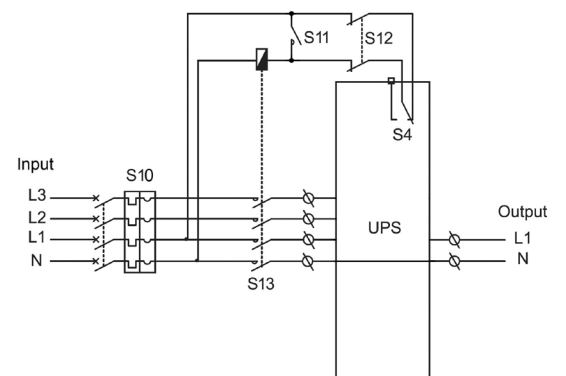

Three phase/Single phase configuration

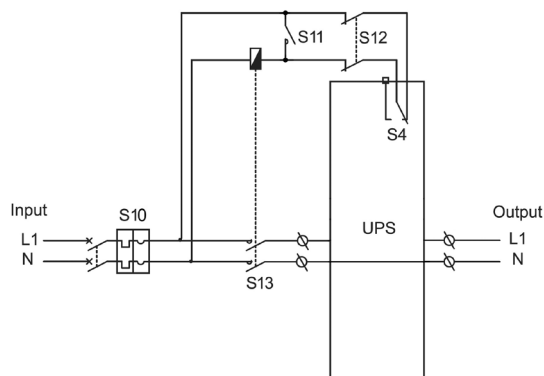

Single phase/Single phase configuration

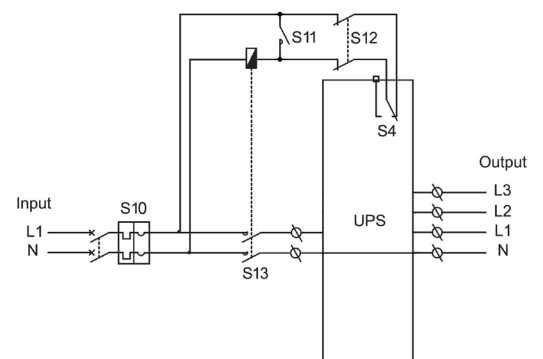

Single phase/Three phase configuration

- S10: thermal-magnetic/differential breakers required for the input line
- S13: input line opening contactor
- S11: disconnector in parallel to the S13 contactor coil
- S12: two-pole disconnector in series to the line to the EC9 connector of the contact interface card
- S4: backfeed auxiliary contact

4. Installation

Connection to a TT or TN-C type distribution network and backfeed circuit connection diagrams with the bypass line separate from the input line

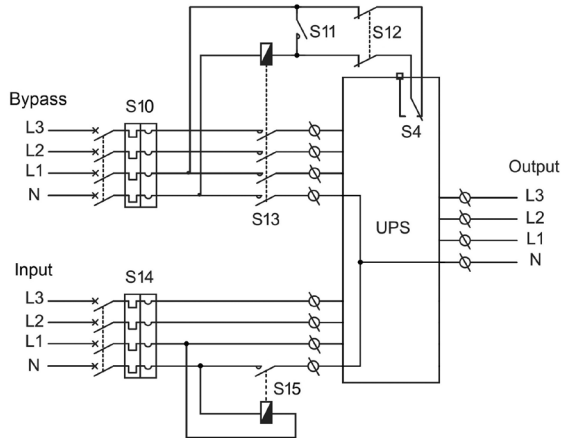

Three phase/Three phase configuration

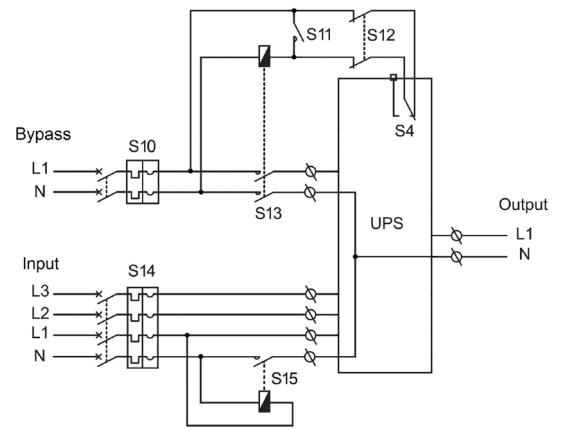

Three phase/Single phase configuration

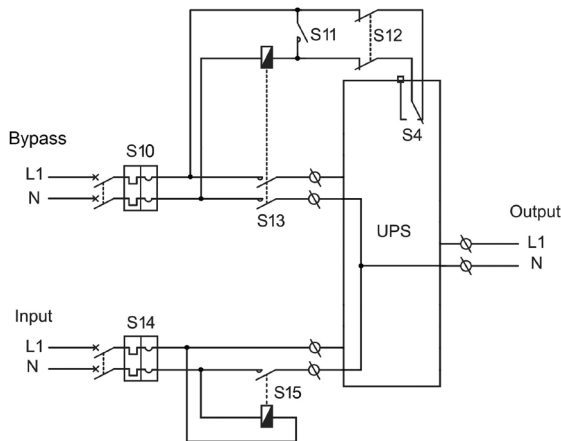

Single phase/Single phase configuration

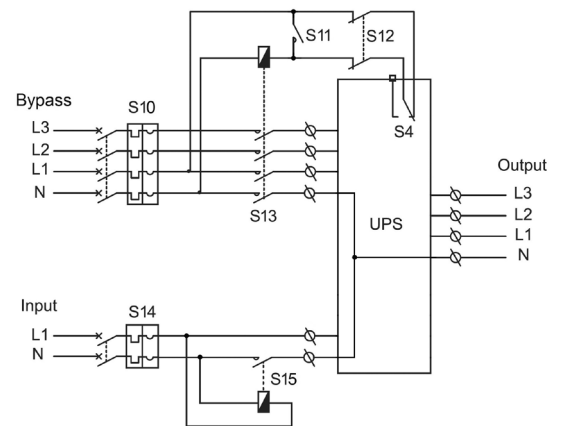

Single phase/Three phase configuration
(available only for SINGLE PHASE input
and THREE INDEPENDENT PHASES output)

- S10-S14: thermal-magnetic/differential breakers required for the input line and the bypass line
- S13: bypass line opening contactor
- S15: network input line neutral opening contactor
- S11: disconnector in parallel to the S13 contactor coil
- S12: two-pole disconnector in series to the line to the EC9 connector of the contact interface card
- S4: backfeed auxiliary contact

Connection to a TN-C type distribution network and backfeed circuit connection diagrams with the bypass line in common with the input line

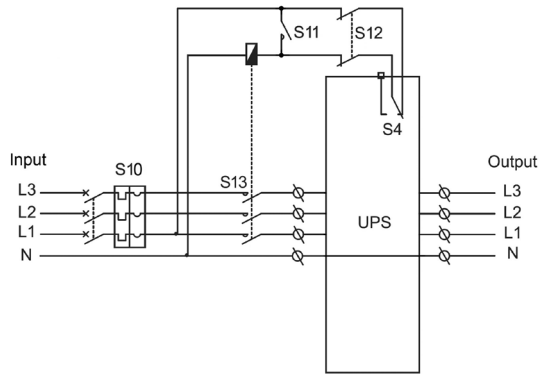

Three phase/Three phase configuration

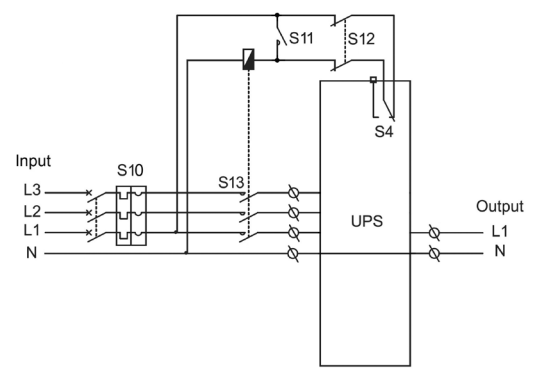

Three phase/Single phase configuration

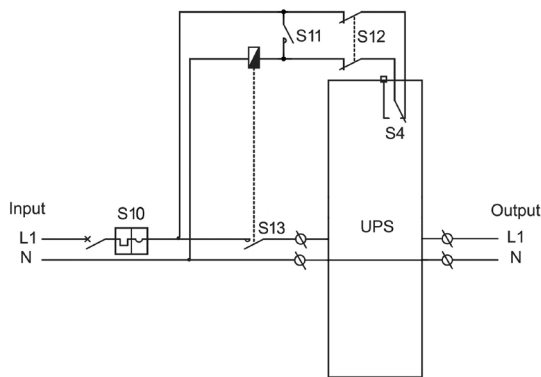

Single phase/Single phase configuration

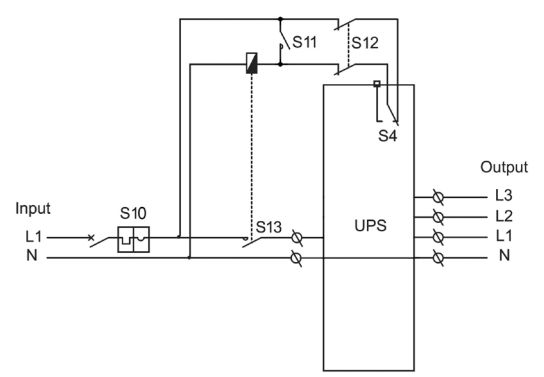

Single phase/Three phase configuration

- S10: thermal-magnetic/differential breakers required for the input line
- S13: input line opening contactor
- S11: disconnector in parallel to the S13 contactor coil
- S12: two-pole disconnector in series to the line to the EC9 connector of the contact interface card
- S4: backfeed auxiliary contact

4. Installation

Connection to a TN-C type distribution network and backfeed circuit connection diagrams with the bypass line separate from the input line

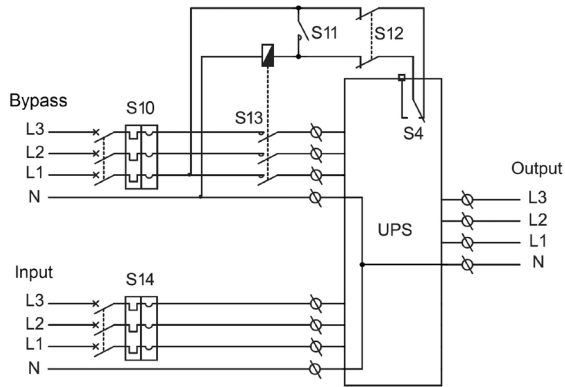

Three phase/Three phase configuration

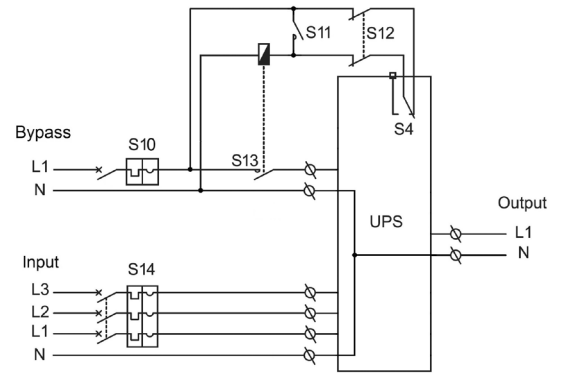

Three phase/Single phase configuration

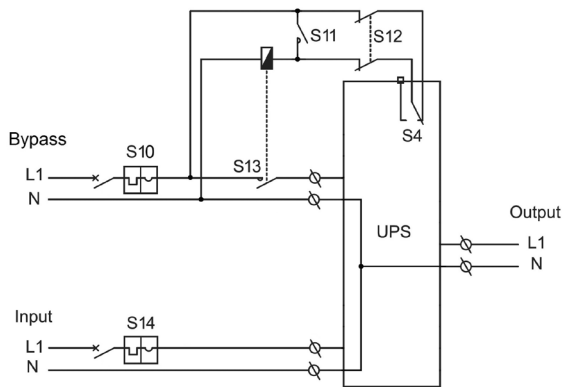

Single phase/Single phase configuration

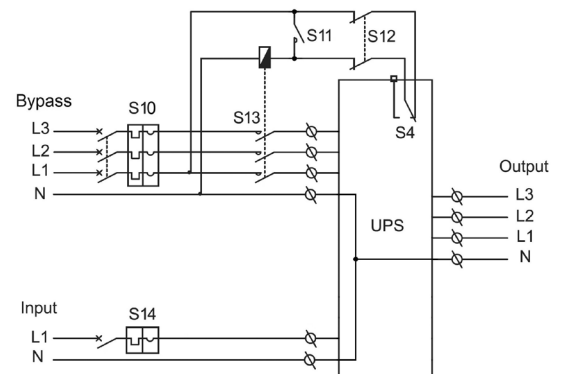

Single phase/Three phase configuration
(available only for SINGLE PHASE input
and THREE INDEPENDENT PHASES output)

- S10-S14: thermal-magnetic/differential breakers required for the input line and the bypass line
- S13: bypass line opening contactor
- S11: disconnector in parallel to the S13 contactor coil
- S12: two-pole disconnector in series to the line to the EC9 connector of the contact interface card
- S4: backfeed auxiliary contact

INDICATION

By protecting external backfeed protection as indicated in the diagrams, it is possible to disconnect the line from the outside and secure it. First close the disconnector S11 in parallel to the contactor coil and then open the double pole disconnector S12 in series to the line towards the EC9 connector.

4.2.7 External battery cabinets installation

In case of UPS without internal batteries, it is necessary to connect external battery cabinets. For models with internal batteries, the installation of external battery cabinets allows to increase the autonomy of the UPS.

Three external battery cabinets models are available:

- a modular model, consisting of a cabinet with an internal structure using battery drawers for a maximum of eighty 12V-7.2 Ah or 12V-9Ah batteries (16 drawers);
- a modular model, consisting of a cabinet with an internal structure using battery drawers for a maximum of one hundred 12V-7.2 Ah or 12V-9Ah batteries (20 drawers);
- compact, non-modular models that uses a shelf architecture that contain twenty 12V batteries inside.



CAUTION

1 KB (Battery Kit) represents a string of 20 batteries in series.

In case of models with internal battery drawers and for external modular battery units, 1 KB comprises 4 battery drawers. It is necessary to install 1 KB every 10 kVA of nominal UPS power in case of modular cabinets with battery drawers. For example, for the Trimod HE 40 it is necessary to have at least one external modular battery cabinet with 4 KB (16 battery drawers).

In case of non-modular external battery cabinets, each unit represents 1 KB and 1 KB is sufficient for all the Trimod HE models.

INDICATION

External battery cabinets can be connected to the Trimod HE 30 TT by means of plates attached to the existing internal fuse holders located in the distribution terminal block. Use M6 screws to connect the eyelet terminals to the plates.

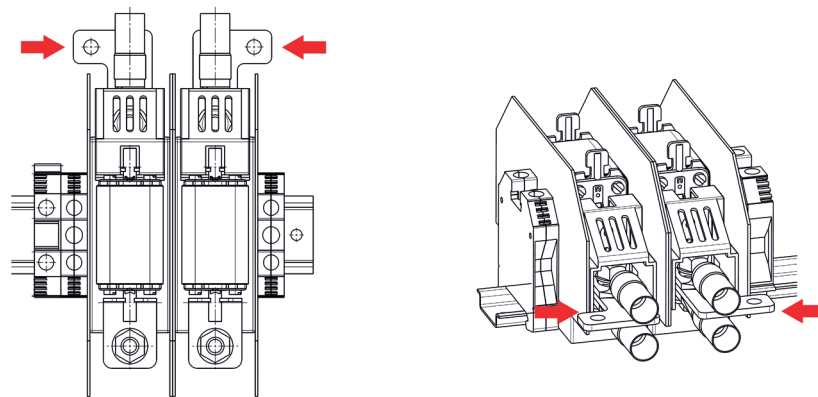

4.2.7.1 Connection of one external modular battery cabinet to the Trimod HE 10-15-20-30TT/TM

The Trimod HE MODULAR BATTERY 4KB-5KB must be connected to the Trimod HE 10, 15, 20 and 30 TT-TM with one of the multipolar cables provided with each battery cabinet.



CAUTION

Table 8 of chapter 10 includes instructions for sizing the cables to connect the UPS to the external battery cabinet in case the multipolar cable provided is not used.

The maximum length of the connection cable between the UPS and the battery cabinet must not exceed 3 meters.

In case of configurations where there are more than one external battery cabinets, it is recommended to implement a battery switchboard as indicated at paragraph 4.2.7.6.

4. Installation

The connection must be made according to the diagram and the passages indicated below:

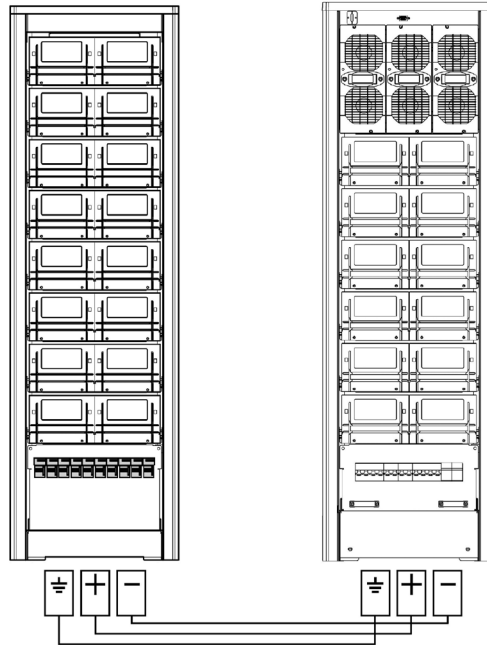

1. Check that all the battery fuse disconnectors are open.
2. Loosen the screws that keep close the panel that gives access to the terminal strips of the external battery cabinets.
3. By using one of the multipolar cables provided with the external battery cabinet, connect the UPS to the external battery cabinet installed using the earthing wire (yellow-green).
4. By means of the multipolar cable used in the preceding point, connect the positive and negative terminals of the UPS with those of the external battery cabinet installed.
5. Refit the panel and tighten the screws.

4.2.7.2 Connection of one external modular battery cabinet to the Trimod HE 40

The Trimod HE MODULAR BATTERY 4KB-5KB must be connected to the Trimod HE 40 with both the multipolar cables provided with each battery cabinet.

CAUTION

Table 8 of chapter 10 includes instructions for sizing the cables to connect the UPS to the external battery cabinet in case the multipolar cables provided are not used.

The maximum length of the connection cable between the UPS and the battery cabinet must not exceed 3 meters.

In case of configurations where there are more than one external battery cabinets, it is recommended to implement a battery switchboard as indicated at paragraph 4.2.7.6.

The connection must be made according to the diagram and the passages indicated below:

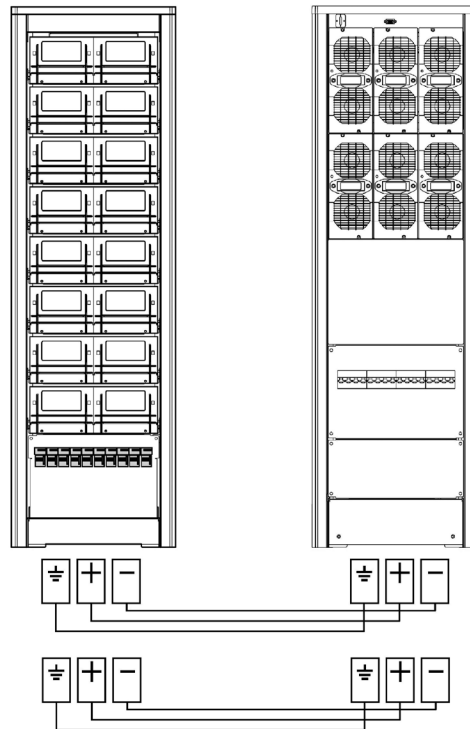

1. Check that all the battery fuse disconnectors are open.
2. Loose the screws that keep close the panel that gives access to the terminal strips of the external battery cabinets.
3. By using both the multipolar cables provided with the external battery cabinet, connect the UPS to the external battery cabinet installed using the earthing wires (yellow-green).
4. By means of the multipolar cables used in the preceding point, connect the positive and negative terminals of the UPS with those of the external battery cabinet installed.
5. Close the panel and tighten the screws.

4.2.7.3 Connection of two external modular battery cabinets to the Trimod HE 60

A Trimod HE 60 can only be connected to two TRIMOD HE MODULAR BATTERY 5 KB (20 battery drawers) using exclusively external cables as per the instructions provided in table 8 of chapter 10.

The multipolar cables provided with each battery cabinet must only be used for the cascade connection of the first external battery cabinet to the second.

CAUTION

The maximum length of the connection cable between the UPS and the first battery cabinet must not exceed 3 meters. It is not possible to connect only one TRIMOD HE BATTERY 5KB to the Trimod HE 60.

The external battery cabinets must be homogeneous in the number of battery drawers. The difference between one cabinet and the other must be a maximum of 1 KB (4 battery drawers).

In case of configurations where there are two or more external battery cabinets, it is recommended to implement a battery switchboard as indicated at paragraph 4.2.7.6.

4. Installation

The cascade connection of the two external battery cabinets must be made according to the diagram and the passages indicated below:

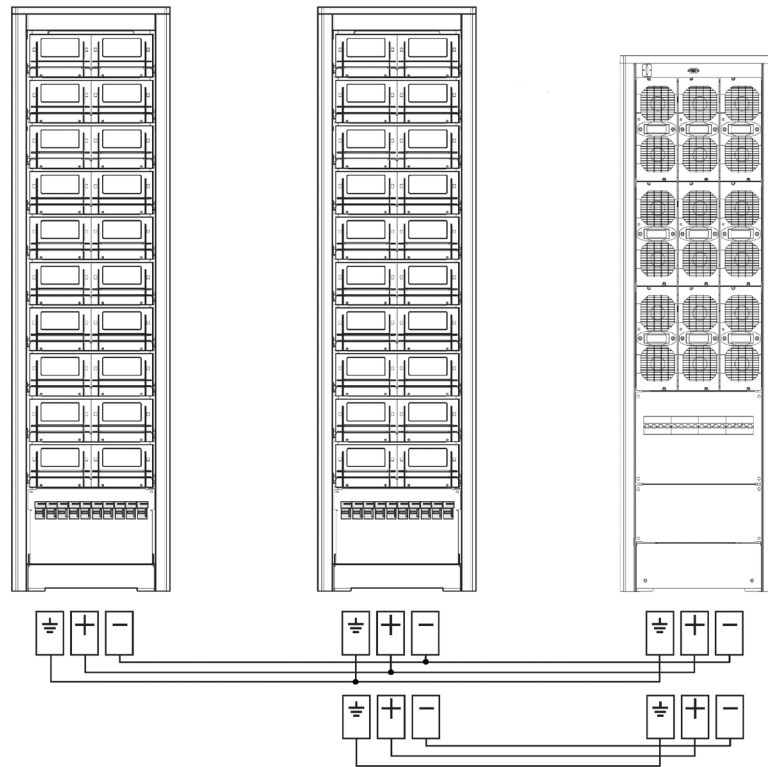

1. Check that all the battery fuse disconnectors are open.
2. Loosen the screws that keep close the panel that gives access to the terminal strips of the external battery cabinets.
3. Connect the UPS and the first external battery cabinet installed using an earthing (green/yellow) cable
4. By means of two cables with minimum cross-section indicated in table 8 of chapter 10, connect the positive and negative terminals of the UPS with those of the first external battery cabinet installed.
5. Connect the first battery cabinet installed with the second using both the multipolar cables provided by connecting the earthing cable first and then the positive and negative terminals.
6. Close the panel and tighten the screws.

4.2.7.4 Connection of the external modular battery cabinets to the Trimod HE 80

It is not possible to connect the external modular battery cabinets to the Trimod HE 80 UPS.

It is only possible to connect the non modular models. It is recommended to implement a battery switchboard as indicated in paragraph 4.2.7.6.

4.2.7.5 Connection of one or more external NON MODULAR battery cabinets to the Trimod HE

Non modular battery cabinets can be connected to the Trimod HE. For the connection, it is necessary to use external cables as set out in Table 8 of Chapter 10.

It is recommended to implement a battery switchboard as indicated in paragraph 4.2.7.6.

4.2.7.6 Connection of one or more external battery cabinets to the Trimod HE

It is recommended to provide a battery switchboard as indicated below if the UPS has to be connected to one or more external battery cabinets:

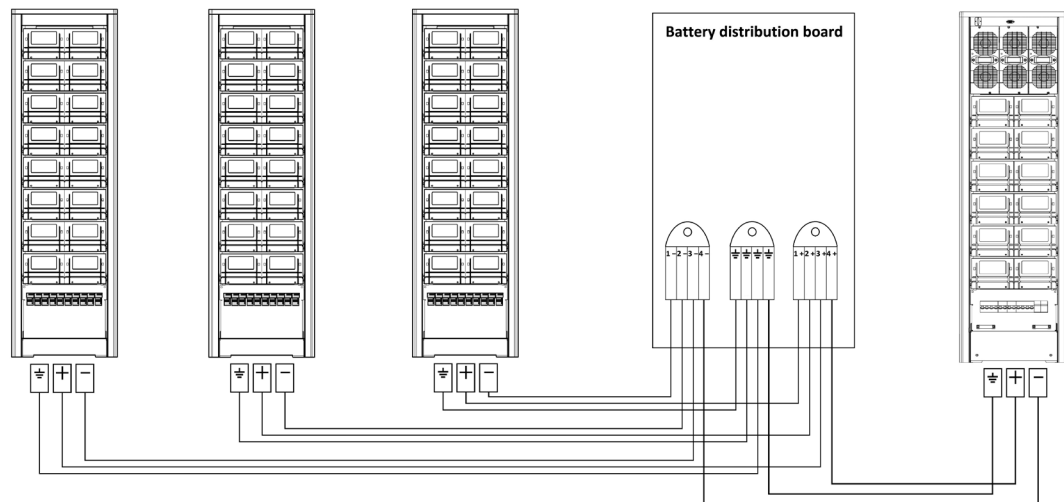

The external modular battery cabinets must be connected to the switchboard with the multipolar cables provided.

The external non modular battery cabinets must be connected with external cables according to the instructions given in table 8 of chapter 10.



ATTENTION

Different connection solutions are the sole responsibility of the installer.

The implementation of the battery switchboard must be carried out according to the local installation regulations and it is a responsibility of the installer.

The length of the connection cable between the UPS and the switchboard must not exceed 3 meters.

The external modular battery cabinets must be homogeneous in the number of battery drawers. The difference between one cabinet and the other must be a maximum of 1 KB (4 battery drawers).

INDICATION

Table 8 of chapter 10 shows the sizing of the cables for connecting the UPS to the battery switchboard.

The input current and the output power of the UPS are indicated in chapter 9 and the battery current in table 8 of chapter 10.

Tables 3 and 4 of chapter 10 provide information to size the fuses to be installed in the external modular battery cabinets.

Table 5 of chapter 10 provides information to size the fuses to be installed in the battery switchboard for the connection with the Trimod HE UPS.

4. Installation

4.2.7 Installation separate batteries

For Trimod HE EVO 30TM, 40, 60 and 80 models (3 104 68, 3 104 71, 3 104 72, 3 1014 73) it is possible to configure separate strings of batteries instead of common ones.

With this configuration, for Trimod HE EVO 30TM and 40 the positive +0 pole is connected to the power modules controlled by the CM0 control board while the positive +1 pole is connected to the power modules controlled by the CM1 control board. For this configuration in the Trimod HE EVO 30TM and 40, perform the following steps:

1. Check that all battery fuse holders are open.
2. Unscrew the screws that keep the panel that allows access to the UPS distribution terminal block closed.

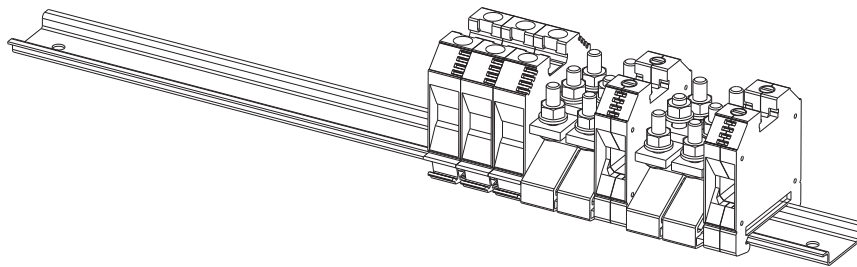

3. Remove the central metal rod between the two positive poles +0 and +1.

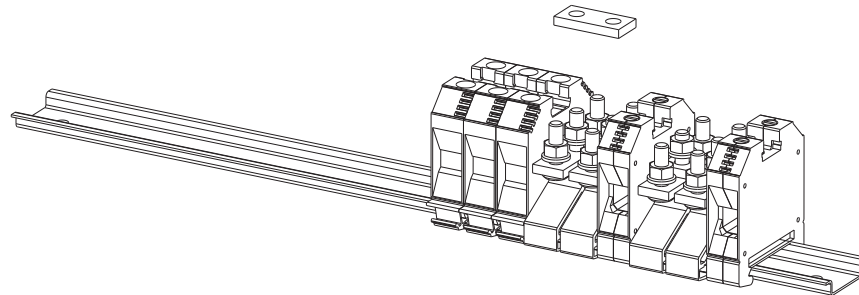

4. Separate the positive terminals +0 and +1 and insert the insulating functional separator supplied in the accessory kit into the DIN rail.

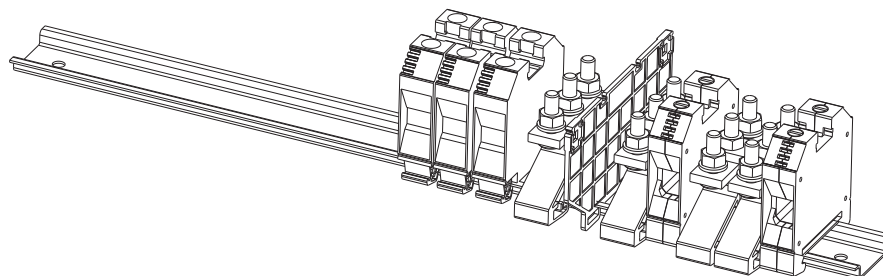

5. Remonter les bornes pour qu'elles adhèrent au séparateur fonctionnel isolant.

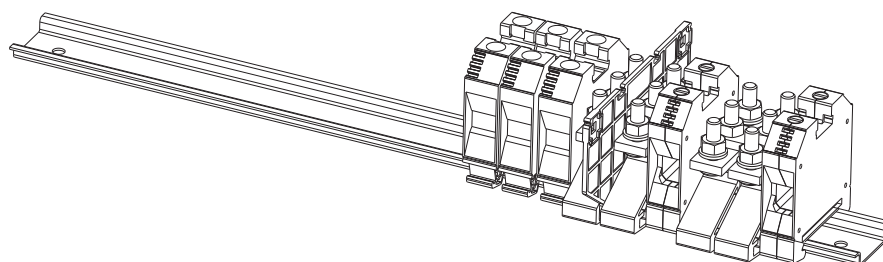

6. Attach the separate batteries label provided in the accessory kit to the area on the connection terminal label where the battery connections are located.

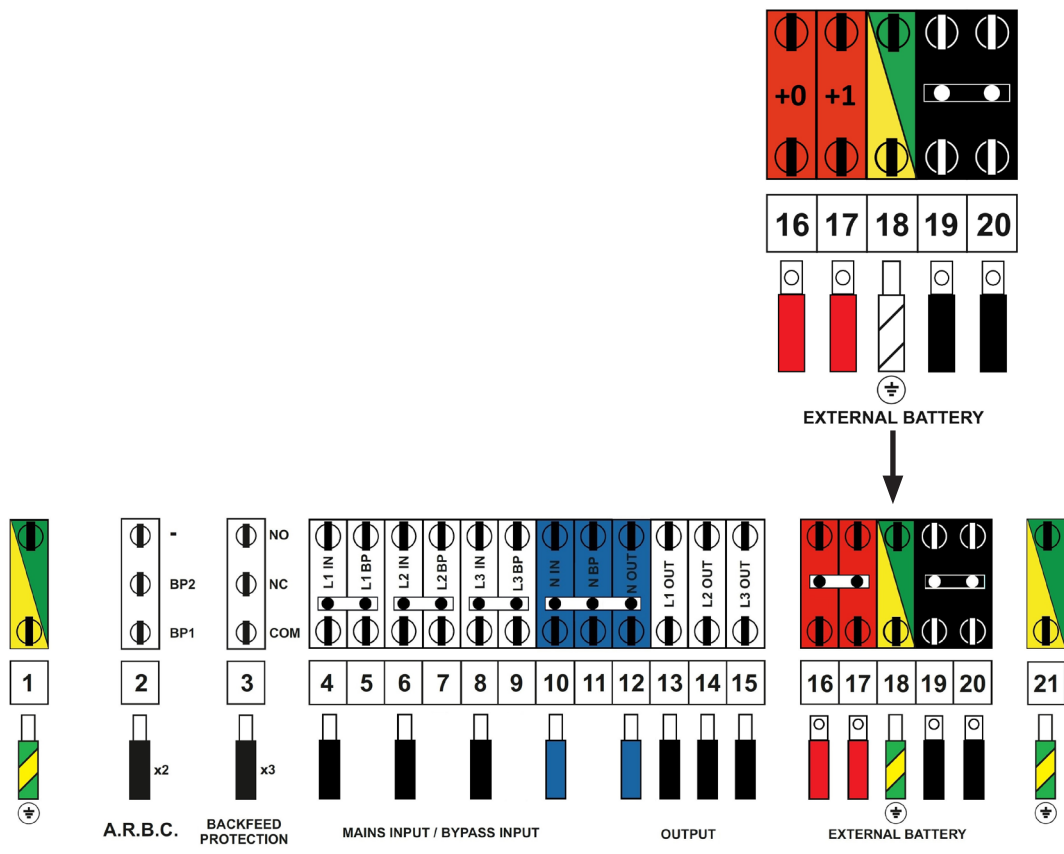

7. Connect the external battery cabinets according to the instructions given in the previous paragraphs.
8. Close the panel and tighten the screws.
9. Configure from the control panel as described in paragraph 5.5.

For the installation of separate batteries on Trimod HE EVO 60 and 80, it is necessary to purchase the kit 3 109 29 and follow the attached instructions.

4.2.8 Mains connection

Before connecting the input power supply cables, check that all the UPS switches are open (OFF position) and arrange the connection jumpers on the terminal strip according to the requested input-output configuration.

INDICATION

Chapter 10 shows the instructions for sizing cables, fuses, automatic and differential breakers. The bypass line is in common with the input line.

The default configuration is THREE PHASE INPUT and THREE PHASE 120° OUTPUT. If this type of configuration is used, the connection jumpers are correctly sized and positioned. For different configurations, it is necessary to consult paragraph 4.3 that includes the connection diagrams and chapter 5.

- The connection must be made according to the following steps:
- Before beginning to connect the mains, check that the available mains power is more than or the same as the nominal UPS input power.
 - Check that the cables to connect to the UPS are isolated upstream and no voltage is present.
 - Check that the earth wire from the low voltage switchgear is connected to the right terminal.
 - Connect the mains input neutral cable to the respective Nin mains input terminal.
 - Connect the cables L1,L2, L3 of the mains line to the respective L1in, L2in e L3in terminals, being careful to observe the phase sequence (L1, L2, L3).

4. Installation



WARNING

The neutral input wire must ALWAYS be connected otherwise the UPS may be damaged irreparably once powered from the mains.

4.2.9 Bypass input line connection (if separate)

The default configuration for the Trimod HE UPS is bypass line in common with the input line.

The connection of a separate bypass line is possible only if the bypass and mains neutral wires are in common (same potential) and the two power supply lines must always have, if applicable, a single differential switch. The UPS has the mains, bypass and output passing neutral and they are connected internally to each other.

INDICATION

Chapter 10 shows the instructions for sizing cables, fuses and automatic/residual current breakers.

To configure a separate bypass line it is necessary to paragraph 4.3 that includes the connection diagrams and chapter 5 for the configuration with the separate bypass input line.

The connection must be performed according to the steps listed below:

- Before beginning to connect the bypass line, check that the available mains power is more than or the same as the nominal UPS input power.
- Check that the cables to connect to the UPS are isolated upstream and no voltage is present.
- Connect the earth wire of the bypass line to the correct terminal at the bottom of the equipment.
- Connect the bypass line neutral wire to the respective Nbyb bypass input terminal.
- Remove the three jumpers linking terminals L1in, L2in, L3in and L1byp, L2byp, L3byp.
- Connect the cables L1, L2, L3 of the bypass input line to the respective L1byp, L2byp and L3byp bypass input terminals, being careful to observe the phase sequence (L1, L2, L3).



WARNING

The separate bypass neutral wire must ALWAYS be connected, otherwise the UPS may be damaged irreparably once powered from the mains.

4.2.10 Output line connection

Before beginning to connect the loads, check that the nominal power of the UPS indicated on the rating plate is more than or the same as the total sum of the load powers. The choice of the type and section of the connecting wires depending on their rated current and installation must be done as indicated in the applicable standards.

INDICATION

Chapter 10 shows the instructions for sizing the output cables

Provide a separate switchgear for the load. It is advisable to use breakers or automatic switches in line with IEC standards to protect the output lines of the switchgear.

Indicate the values reported below on the system switchgear by means of stickers or similar:

- maximum nominal power of the total load;
- maximum nominal power of the load at the load outlets;
- if a common switchgear is used (mains and UPS power outlets), make sure that there is an indication of the relative power source on every power outlet ("Mains" or "UPS").

The default configuration is the THREE PHASE INPUT and THREE PHASE 120° OUTPUT.

If this configuration is used, the connection jumpers are correctly sized and positioned. For different configurations, it is necessary to consult paragraph 4.3 that includes the connection diagrams and chapter 5.

The connection must be made according to the following steps:

- Before beginning to connect the output, check that the UPS is off and that the output terminals are not live.
- Connect the earth wire of the output line to the correct terminal.
- Connect the output neutral wire to the respective Nout output terminal.
- Connect individually the cables L1, L2, L3 of the output line to the respective L1out, L2out and L3out output terminals, being careful to observe the phase sequence (L1, L2, L3).

4.3 Wiring diagrams

The electrical configuration must be done on both the control panel and on the distribution terminal strip. For the explanation of the significance of the A.R.B.C terminal, see paragraph 4.3.8.



WARNING

Always check that the connection jumper screws are tightened properly. If the configuration set in the factory is modified, it is necessary to configure the new functioning mode through the control panel as indicated in chapter 5.

4.3.1 Factory configuration: THREE PHASE input – THREE PHASE output with common bypass input line

The UPS default configuration is set in the factory according to the following diagrams depending on the model. To use this configuration, no further action is necessary; it is however recommended that a check is made of the correct configuration of the connection jumper.

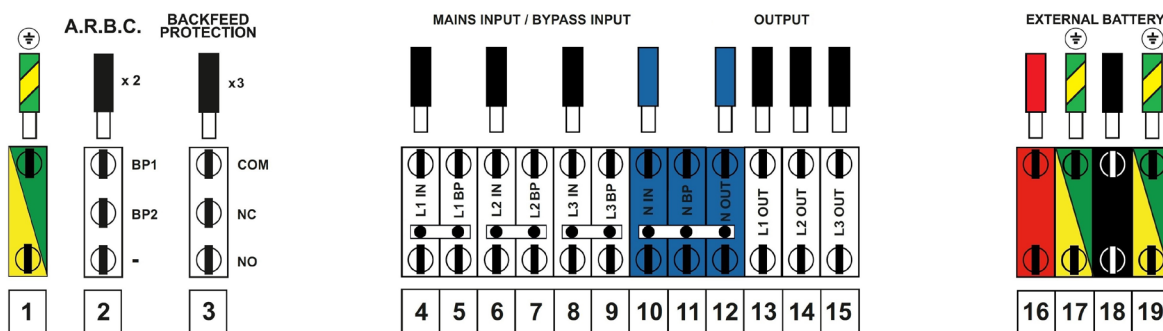

Trimod HE 10 - 15 - 20

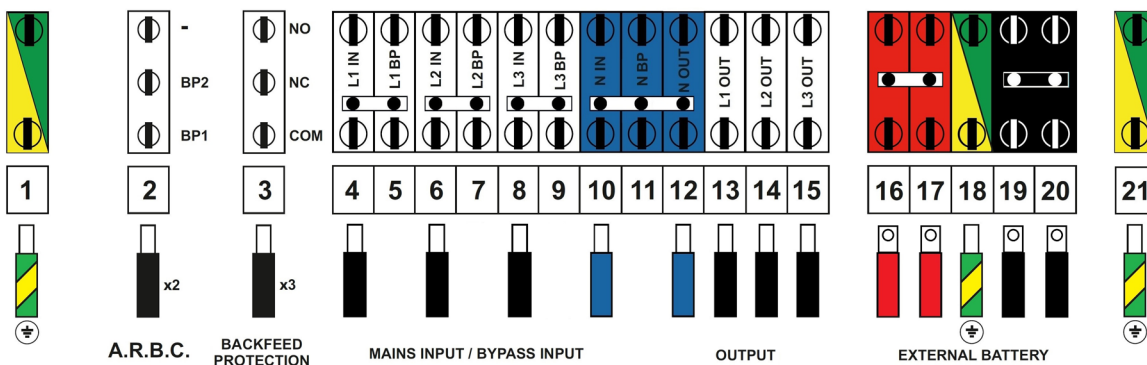

Trimod HE 30 TM and Trimod HE 30 TT (models 3 104 24 and 3 104 17 only)

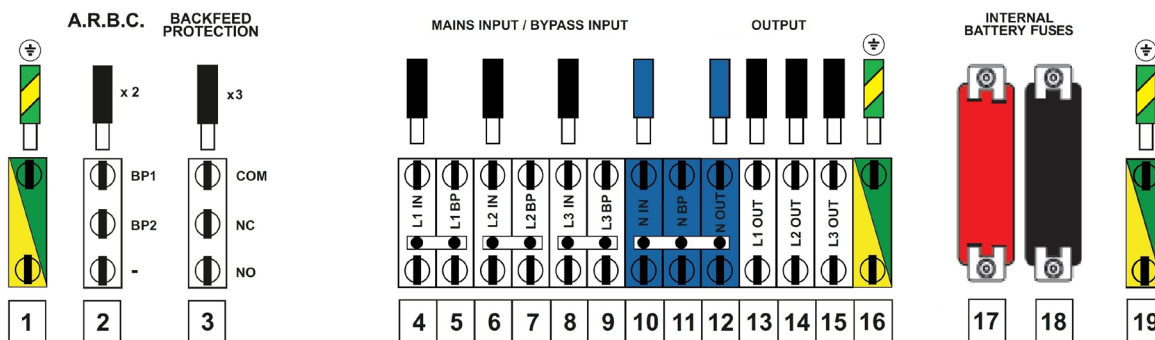

UPS Trimod HE 30 TT

4. Installation

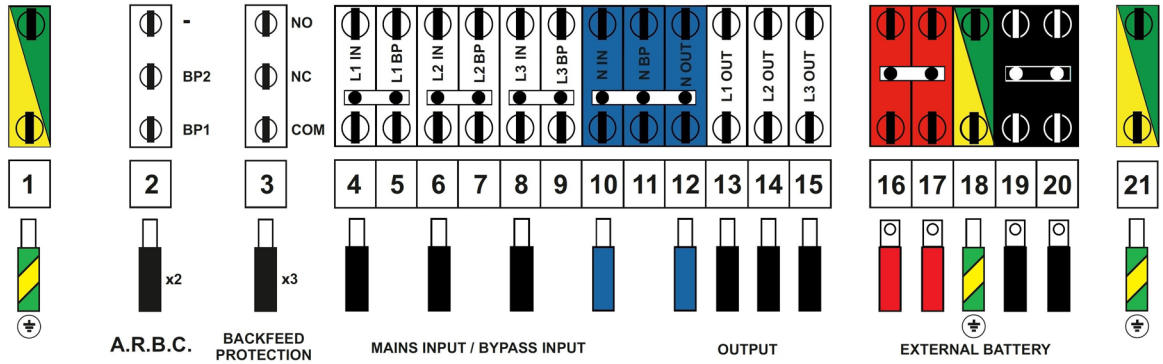

Trimod HE 40 – 60

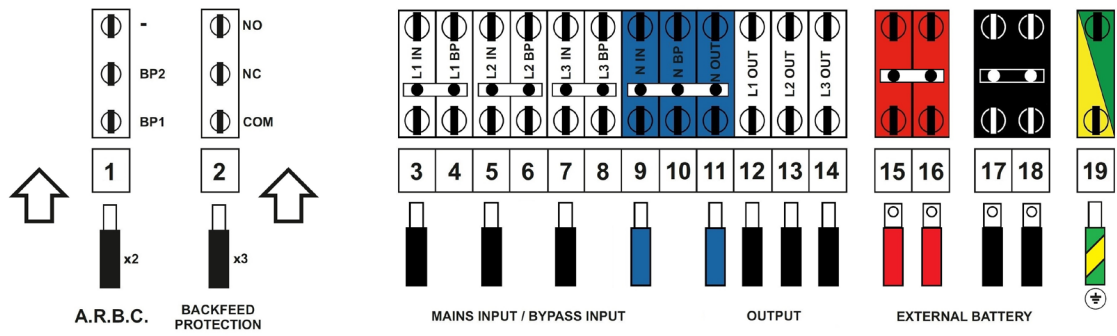

Trimod HE 80

4.3.2 THREE PHASE input - THREE PHASE output connection with separate bypass input line

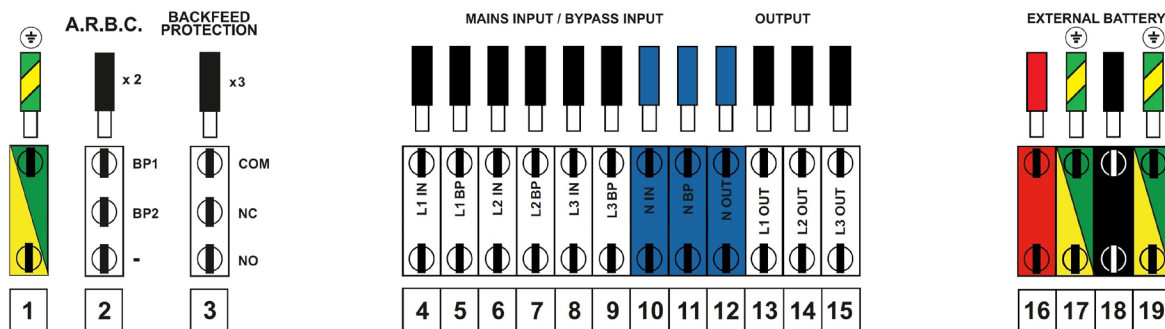

Trimod HE 10 - 15 - 20

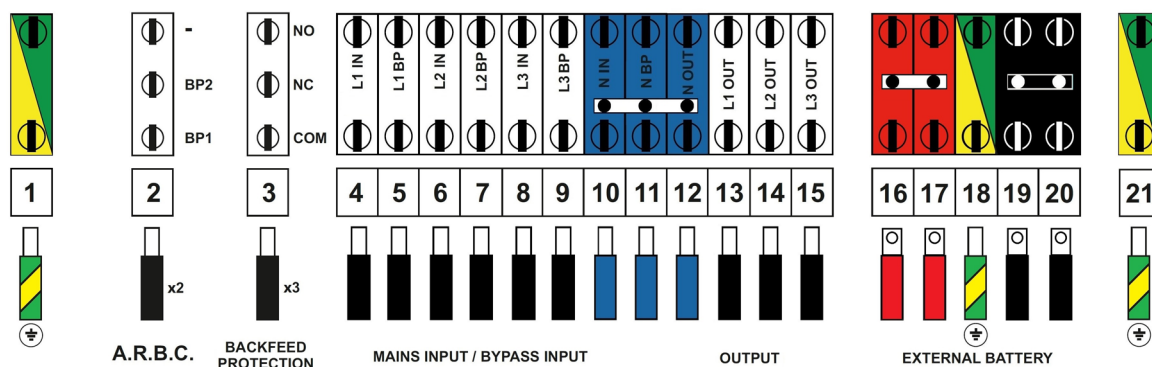

Trimod HE 30 TM and Trimod HE 30 TT (models 3 104 24 and 3 104 17 only)

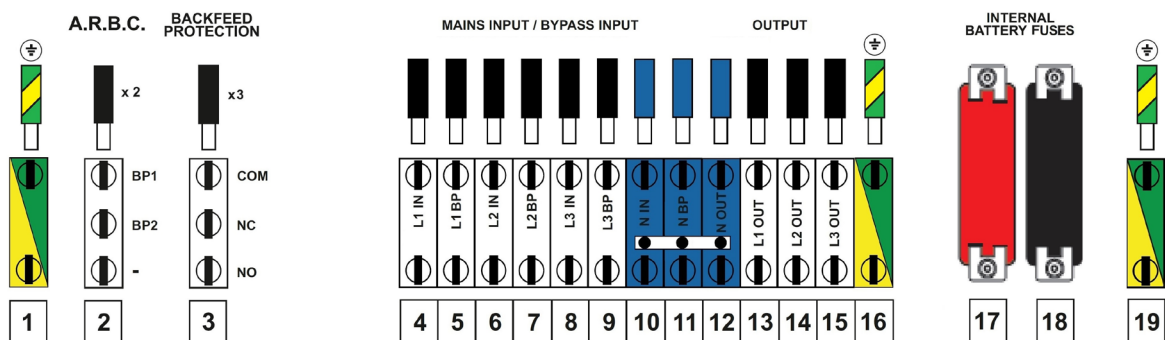

Trimod HE 30 TT

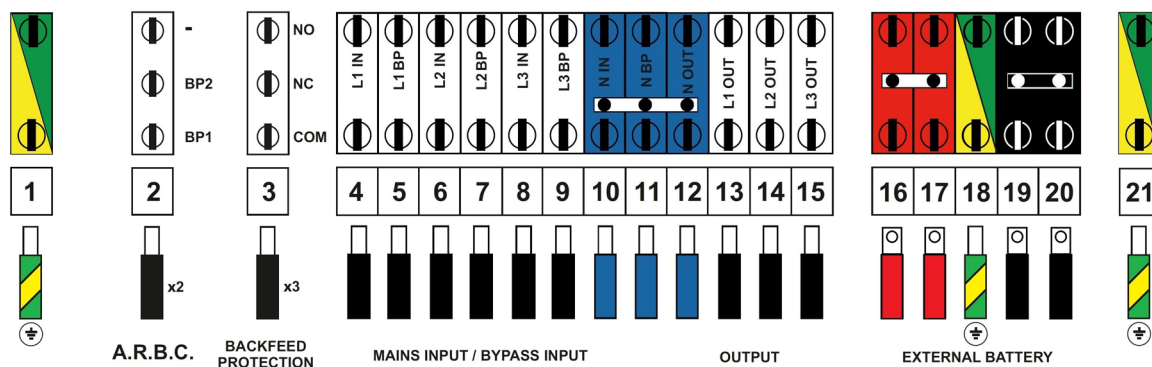

Trimod HE 40 - 60

4. Installation

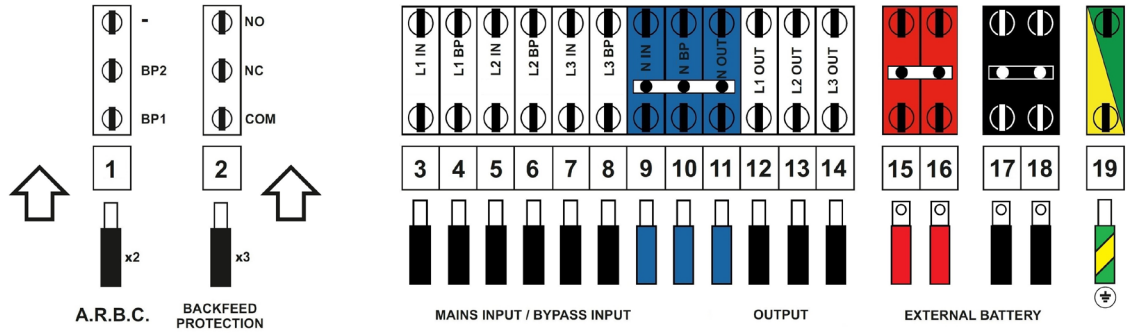

Trimod HE 80

4.3.3 THREE PHASE input – SINGLE PHASE output connection

This connection is available only for Trimod HE 10, 15, 20 and 30 TM.

In addition to the wiring shown in the images that follow, it is necessary to configure the functioning mode as illustrated in chapter 5.

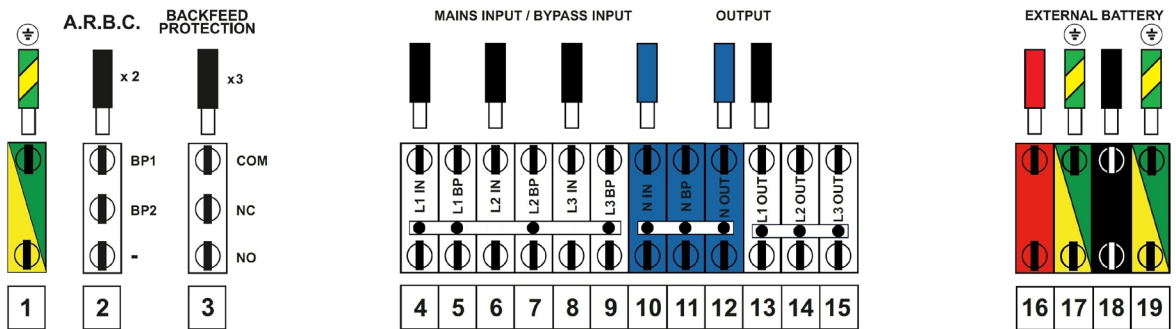

Trimod HE 10 - 15 - 20
with common bypass input line

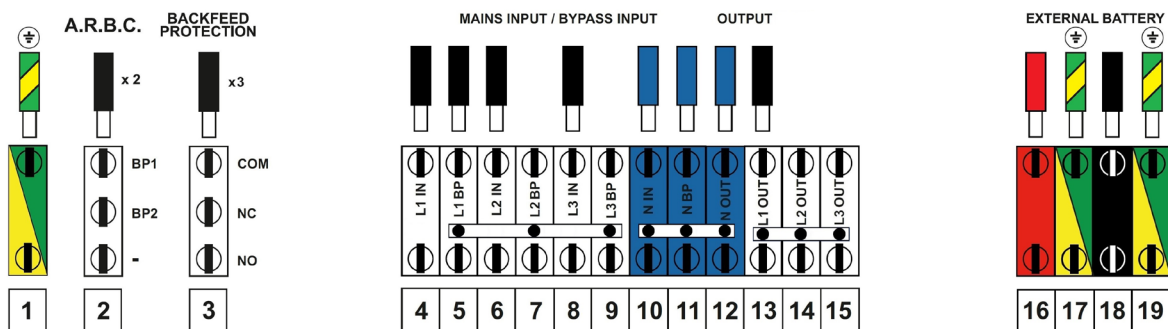

**Trimod HE 10 - 15 - 20
with separated bypass input line**

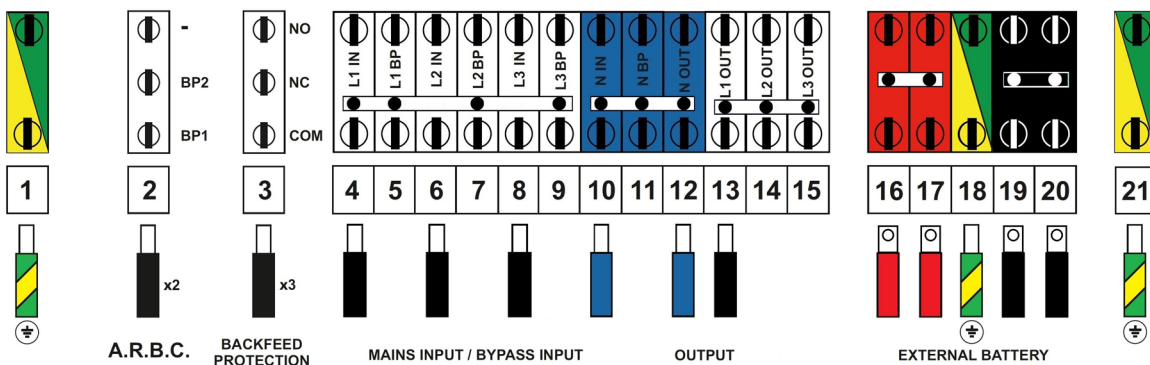

**Trimod HE 30 TM
with common bypass input line**

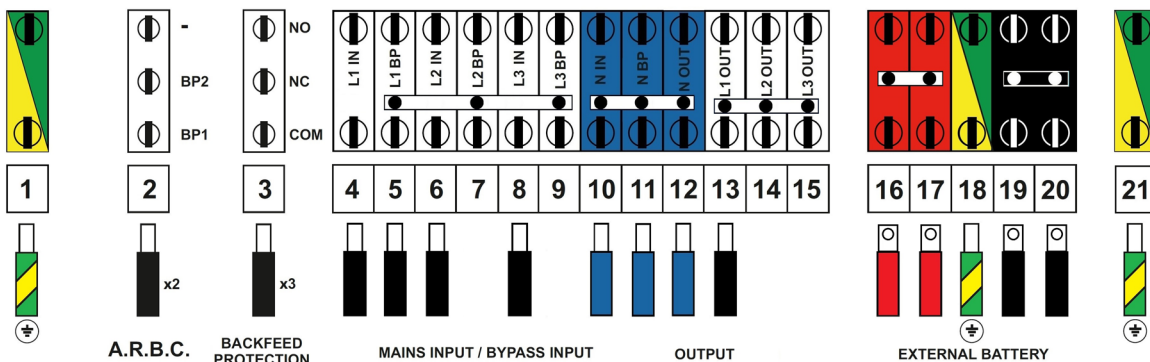

**Trimod HE 30 TM
with separated bypass input line**

4. Installation

CAUTION

For the configuration with single phase output, it is necessary to insert in all the back panel boards a special connector provided in the accessory kit.

The back panel boards are located in the equipment behind the power modules. In the Trimod HE 10, 15 and 20 models there is just one back panel board. In the Trimod HE 30 kVA TM model there are two back panel boards.

The connector must be inserted in the position indicated by EC 15 serigraphed onto the board as shown in the following figure:

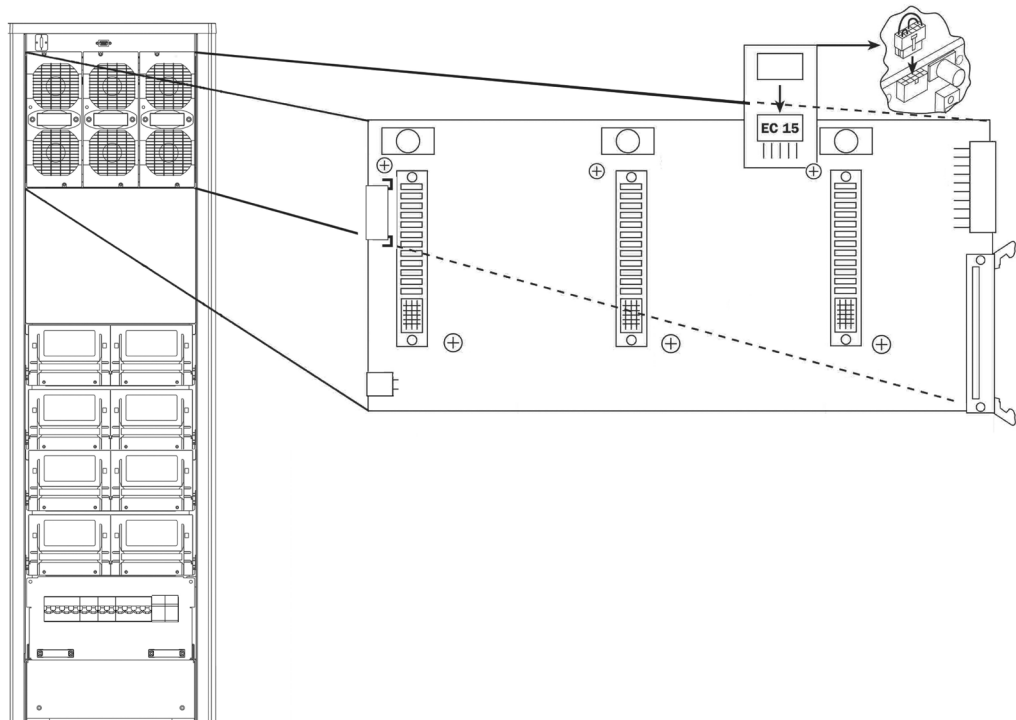

4.3.4 SINGLE PHASE input – SINGLE PHASE output connection

This connection is available only for Trimod HE 10, 15, 20 and 30 TM.

In addition to the wiring shown in the images that follow, it is necessary to configure the functioning mode as shown in chapter 5.

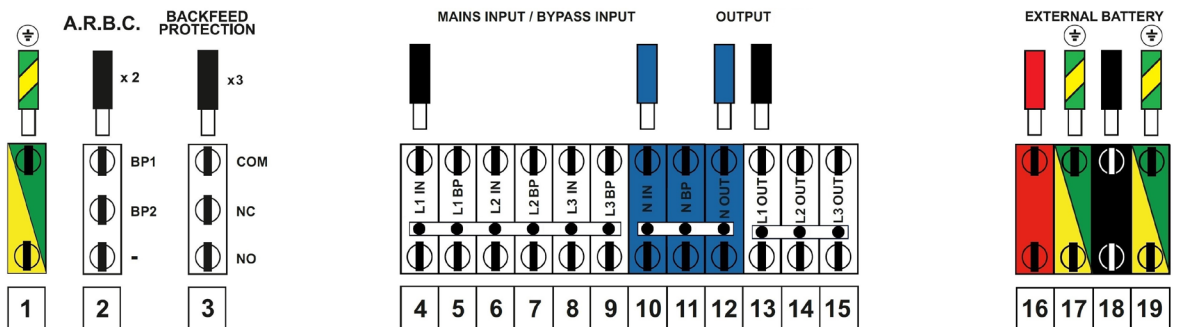

**Trimod HE 10 - 15 - 20
with common bypass input line**

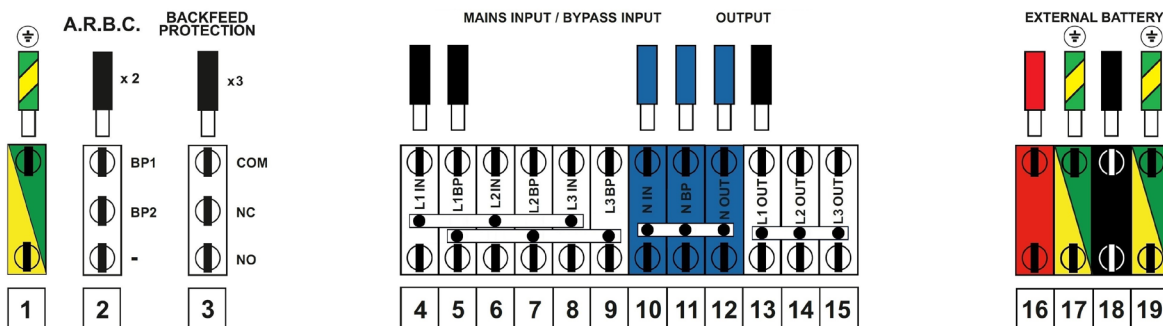

Trimod HE 10 - 15 - 20
with separated bypass input line

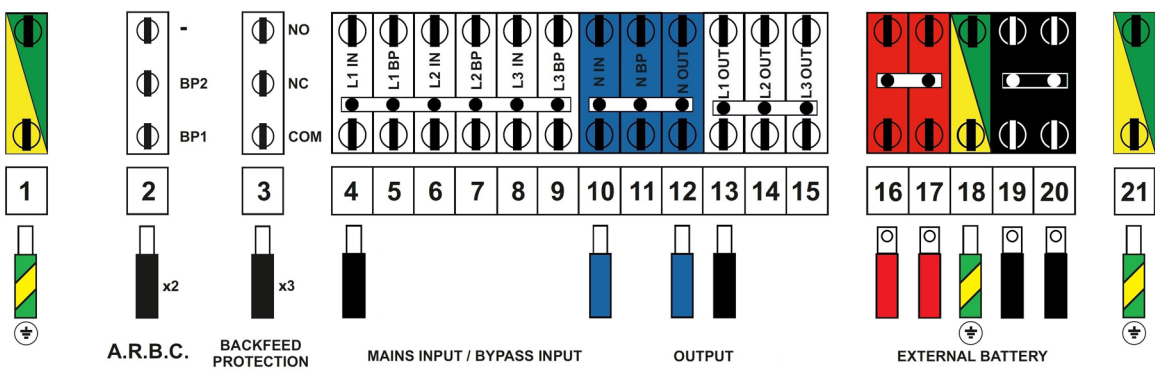

Trimod HE 30 TM
with common bypass input line

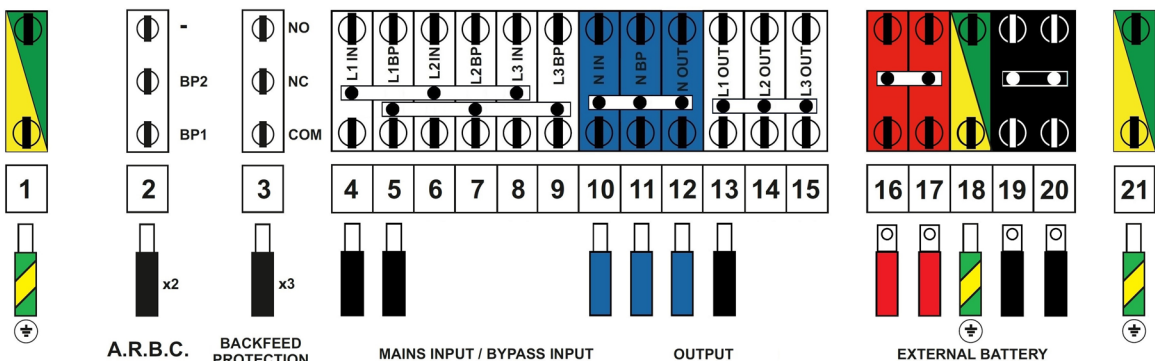

Trimod HE 30 TM
with separated bypass input line

4. Installation



CAUTION

For the configuration with single phase output, it is necessary to insert in all the back panel boards a special connector provided in the accessory kit.

The back panel boards are located in the equipment behind the power modules. In the Trimod HE 10, 15 and 20 models there is just one back panel board. In the Trimod HE 30 TM there are two back panel boards.

The connector must be inserted in the position indicated by EC 15 serigraphed onto the board as shown in the following figure:

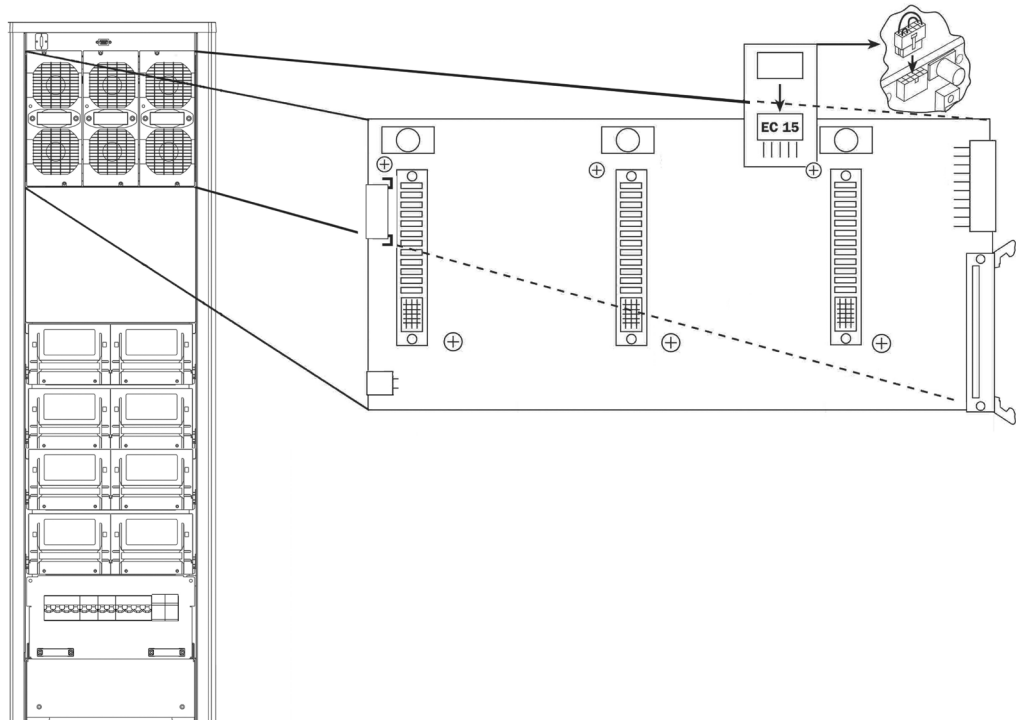

4.3.5 SINGLE PHASE input - THREE PHASE 120° output connection

This connection is available only for Trimod HE 10, 15, 20 and 30 TM.

In addition to the wiring shown in the images that follow, it is necessary to configure the control panel functioning mode as shown in chapter 5.

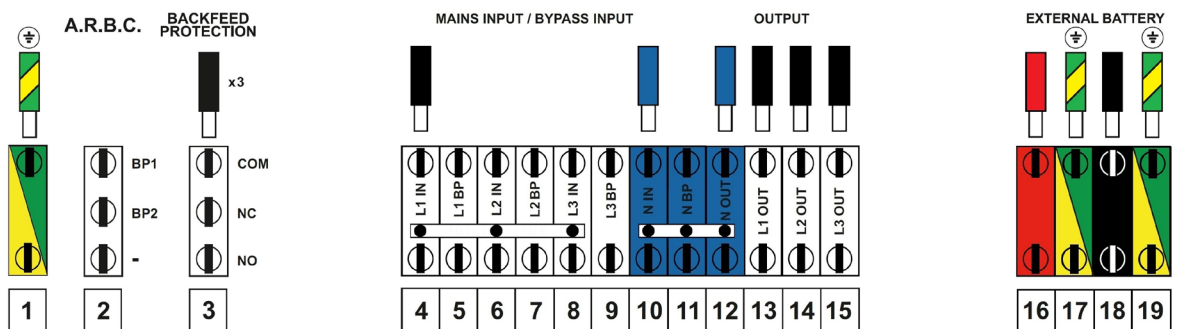

Trimod HE 10 - 15 - 20
(with disabled bypass input line)

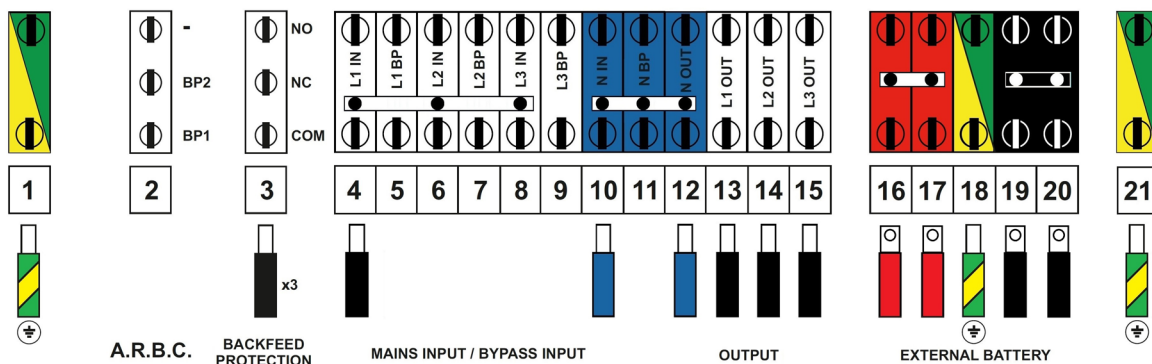

Trimod HE 30 TM
(with disabled bypass input line)



CAUTION

The bypass function is not available for the configuration with single phase input and three phase 120° output. The manual maintenance bypass switch S1 and bypass input line switch S5 must NEVER be activated. For greater safety, it is possible to completely eliminate the manual maintenance bypass by cutting the brown, black and grey cables that connect the relative S1 switch to the output S2 switch and being careful to isolate the wires adequately.

4.3.6 SINGLE PHASE input - THREE INDEPENDENT PHASE output connection

This connection is available only for Trimod HE 10, 15, 20 and 30 TM.

In addition to the wiring shown in the images that follow, it is necessary to configure the functioning mode as shown in chapter 5.

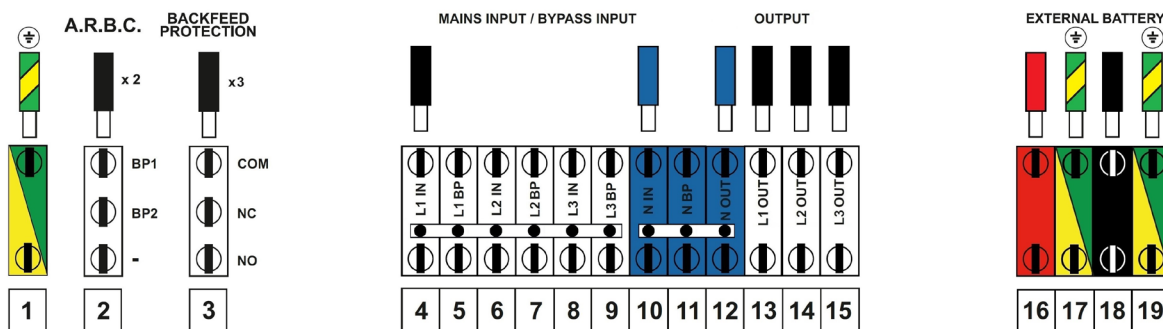

Trimod HE 10 - 15 - 20
with common bypass input line

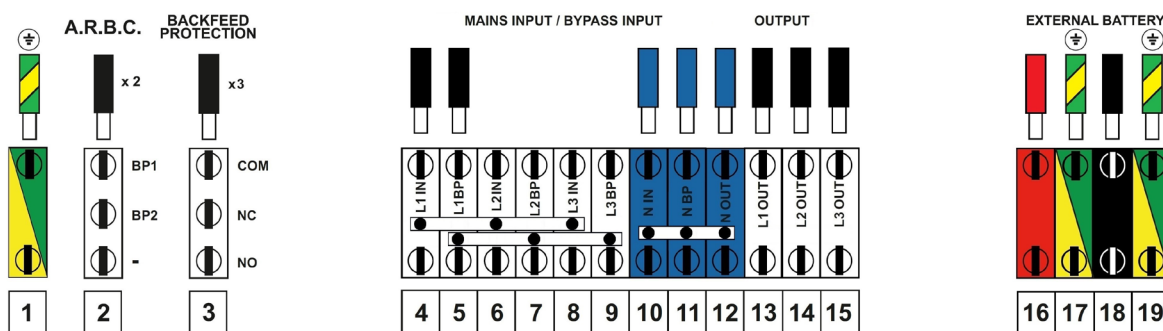

Trimod HE 10 - 15 - 20
with separated bypass input line

4. Installation

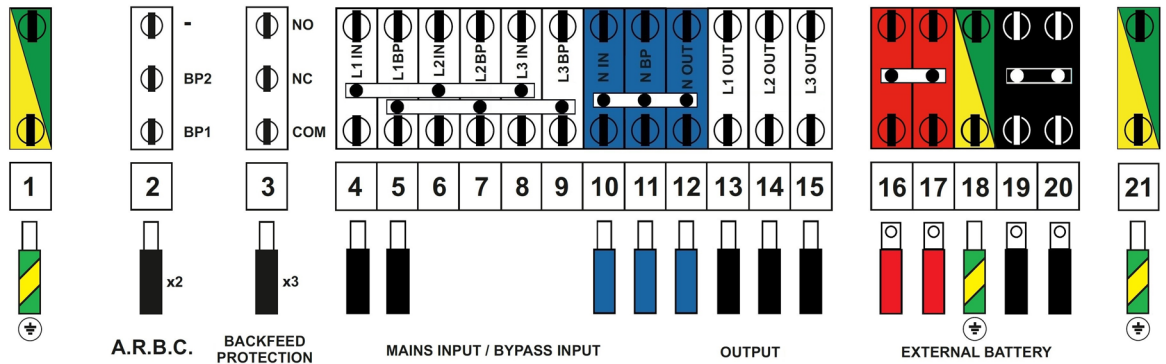
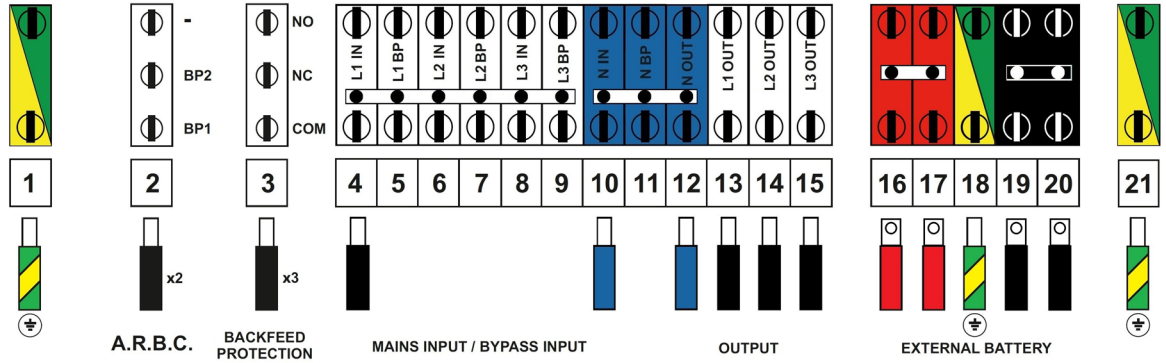

4.3.7 Installation of the connection jumpers

1. Take one of the connection jumpers out of the accessory envelope and cut it so as to make it the requisite length. Check that after the cut there are no burrs that could cause contact with adjacent jumpers.

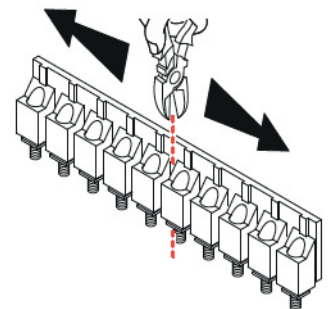

2. Eliminate the vertical connections that are not represented in the connection diagrams.

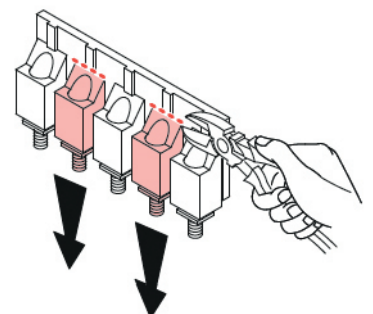

3. Insert the jumper into the terminal strip as shown in the connection diagrams.

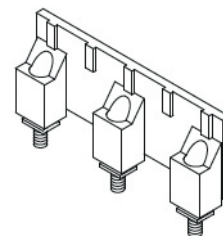

4. Carefully tighten all the screws to the terminal strip.

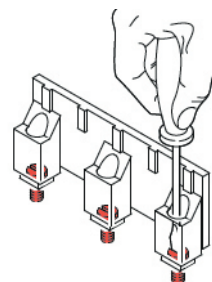

5. Tighten up the terminal strip.

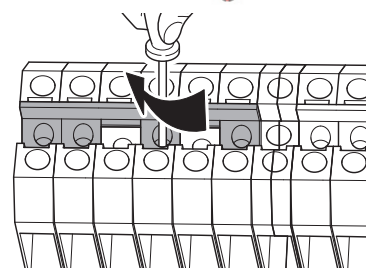

6. Use the screwdriver to extract the yellow plastic part.

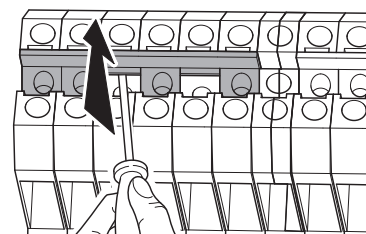

7. Check that the screw head abuts properly on the terminals.

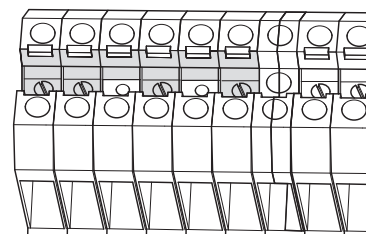

8. Reinsert the yellow plastic part.

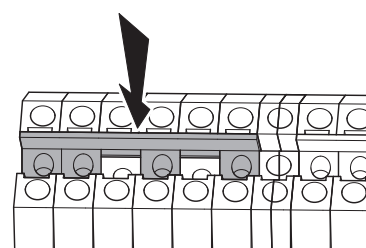

4. Installation

4.3.8 ARBC (Auxiliary Remote Bypass Contact)

Trimod HE UPS makes it possible to enable forced bypass mode without any operation from the control panel but simply through a normally open external contact.

The external bypass contact terminal is found on the terminal strip and is marked by the wording "A.R.B.C.":

For the correct connection of the external contact, the following requirements must be adhered to:

- use a double-insulation cable of up to 10 meters in length;
- make sure that the switch used is galvanically isolated.

The electric characteristics of the auxiliary remote bypass contact are the following:

- voltage with open contacts: less than 100 V
- current with closed contacts: less than 100 mA

The figure below shows how the external bypass contact connection must be made:

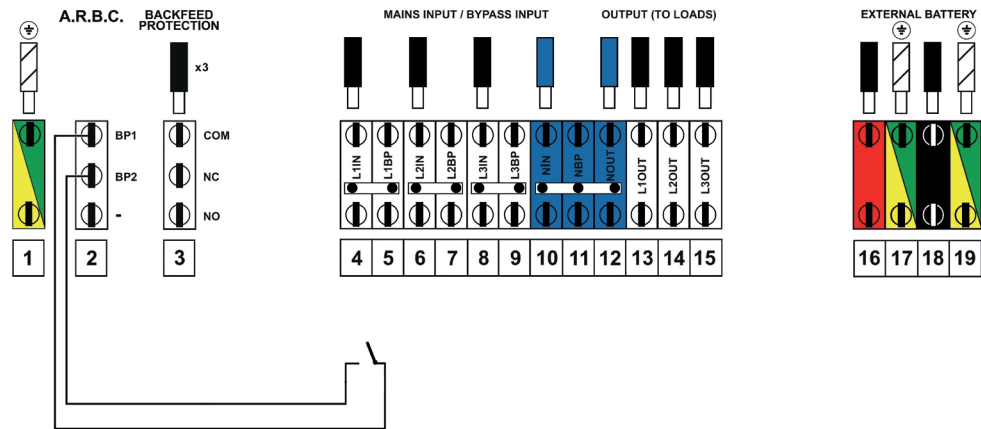

CAUTION

It is not possible to use the auxiliary contact if the UPS is configured as a single phase input-three phase 120° output.

4.4 Insertion of power modules and battery drawers

Once all the electrical connections have been made, close the distribution drawer for the Trimod HE 10, 15, 20, 30 TT models or screw up the lower panels for the Trimod HE 30 TM, 40, 60 and 80.

It is then possible to move onto the insertion of the power modules and battery drawers into the UPS (depending on the model) and in the external modular battery cabinets (if there are any).



WARNING

The Trimod HE UPS have electrical distribution sized for the nominal power of the equipment and must be used exclusively with the power modules provided as shown in the "Mechanical characteristics" table in chapter 10 of this manual.

Do not use power modules that differ from those indicated and do not exchange the modules with each other and/or replace them to vary the power of the UPS.

The model, the nominal power and the type of power module to be installed in the Trimod HE UPS are indicated in the manuals and on the rating plate inside the door of the UPS.

The type and the nominal power of the power module are indicated on a rating plate at the back of the module.

Insert the power modules one at a time checking that they abut. Fix them to the frame with the two screws provided with each module. Use SHC M4x20 screws (hex socket head). The two fixing screws also act as the module's earth connection and must both be fixed for safety purposes.

If one or more power modules are not installed, the free slots must be covered by installing in each of them the plastic mask of the kit 3 108 66. The mask must be fixed with two SHC M4x20 screws.

Insert the battery drawers one at a time checking that they abut. For each drawer, tighten all the fixing screws provided. Use SHC M4x20 screws (hex socket head).

In the case of the Trimod HE 30 TT do not insert abutted the drawers and do not screw them up.

If one or more battery drawers are not installed, the free slots must be covered by installing in each of them the plastic mask of the kit 3 108 65. The mask must be fixed with two SHC M4x20 screws.

4.5 Communication devices

The Trimod HE UPS have two RS232 serial ports, one relay contacts card, one logic level interface on DB15 socket and one SNMP slot.

The communication interfaces are found in the rear of the UPS. The RS232 serial maintenance port is inside the UPS door, above the first row of power modules.



CAUTION

For the operator's safety it is essential the interfaces are connected in such a way that :

- the maximum voltage between any two wires connected to the interface and between any one of these wires and the earth is less than 42Vpk or less than 60Vdc;
- the isolation voltage between any wire connected to the interface and the earth is at least 1500Vac.

4.5.1 RS232 serial ports

The first of the two RS232 serial ports is called "maintenance RS232" and is found above the first row of power modules, in a part accessible only to a skilled technician with a key to open the UPS door. The maintenance RS232 is dedicated exclusively to diagnostic functions and to update the equipment firmware.

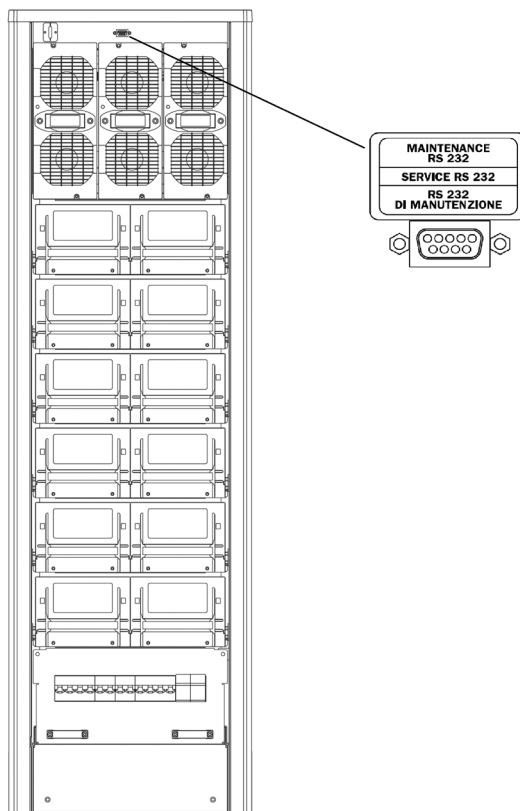

The second serial port called "user interface" is located at the back of the UPS. This port makes it possible to access a set of data relative to the functioning of the UPS as well as controlling the unmanned shutting down of the operating system through a computer or a specific network card.

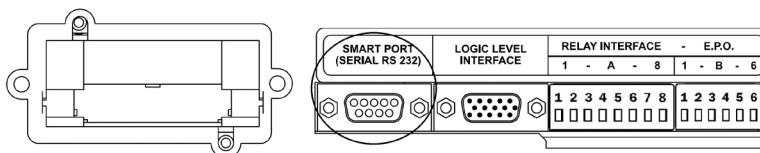

4. Installation

The pinout of the RS232 interface is the following:

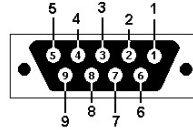

PIN	FONCTION
2	RX
3	TX
5	GND
1 - 4 - 6	(connected together)
7 - 8	(connected together)

4.5.2 Relay interface

The notifications available through this interface are:

- battery mode functioning
- autonomy reserve
- generic alarm
- overload
- UPS in bypass mode
- UPS normal mode functioning

The contacts of the relay interface are programmed in default mode as normally open (NO) but can be configured as normally closed (NC) from the control panel (see par. 5.4.2 user manual - path **UPS Setup** → **Dry contacts**). The contacts are located on the back of the UPS and are available through 8 and 6 pole connectors.

The electric characteristics of the relay interface are the following:

- VMAX = 250 Vac / 30 Vdc.
- IMAX = 5 A.

The pinout of the contact interface is described below:

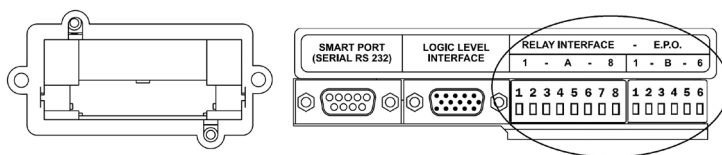

PIN	CONNECTOR A
	FUNCTION
1 - 2	Contact 1 default: battery mode functioning
3 - 4	Contact 2 default: autonomy reserve
5 - 6	Contact 3 default: generic alarm
7 - 8	Contact 4 default: overload

PIN	CONNECTOR B
	FUNCTION
1 - 2	Contact 5 default: UPS in bypass mode
3 - 4	EPO (see section 5.5.3)
5 - 6	-

4.5.3 Emergency Power Off (EPO)

The UPS has an external normally closed contact that can be opened to activate the immediate stop of the equipment. The EPO terminal is at the back of the UPS on pins 3 and 4 of the 6-pole connector on the relay interface:

For the correct connection of the EPO, the following requirements must be adhered to:

- use a double-insulation cable of up to 10 meters in length;
- check that the switch used is galvanically isolated.

INDICATION

It is not possible to connect the EPO circuits of different UPSs in parallel. If necessary, use contacts on the EPO emergency pushbutton isolated from each other.

The electric characteristics of the EPO interface are:

- voltage between terminals 3 and 4 (6-pole connectors) with open circuit: 12Vdc.
- current between terminals 3 and 4 (6-pole connectors) with closed circuit: 5mA.

The figure below shows how the EPO connection must be made:

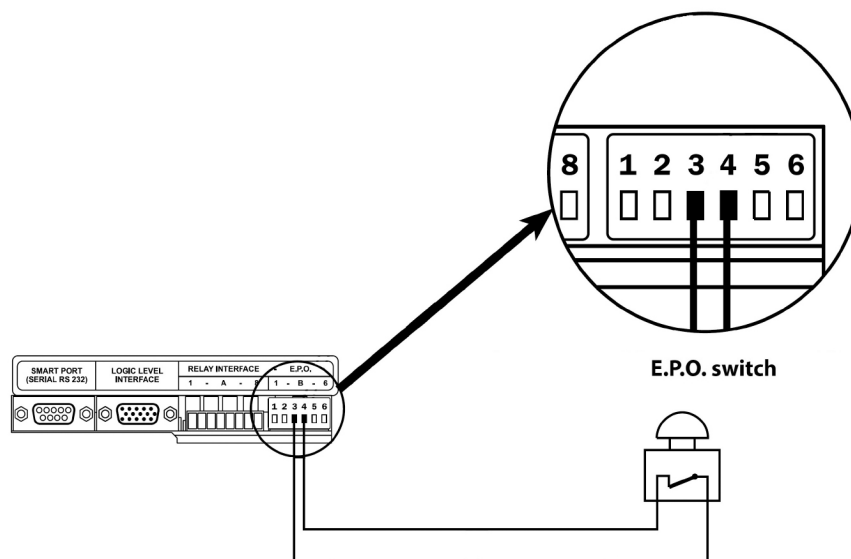

4.5.4 Logic level interface

The logic level interface is available on connector DB15 at the back of the UPS and makes it possible to connect the UPS in remote control mode with the aim of monitoring its functioning status. The following control signals are available:

- mains/battery functioning
- autonomy reserve
- UPS Fault
- Overload
- UPS in bypass mode
- ON/OFF input

The electric characteristics of the logic level interface are the following

- Logical output: VMAX = 12 Vdc , impedance on output: 2,2 kΩ in series
- Power supply: 12 Vdc , IMAX = 700 mA - not regulated
- Open collector outputs: 30 Vdc , IMAX = 100 mA.

The pinout of the interface is described below:

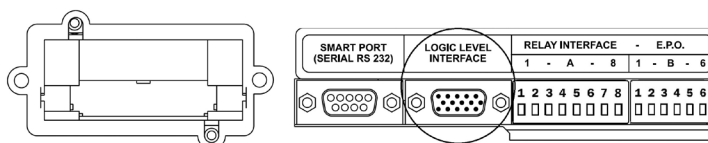

4. Installation

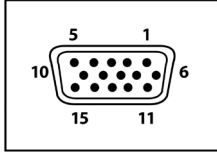

PIN	FUNCTION
1	GND
2	Mains / Battery (output, active high)
3	Autonomy reserve (output, active high)
4	Power supply
7	Overload (open collector, active low)
12	UPS in battery mode (open collector, active low)
13	UPS in bypass mode (open collector, active low)
14	Autonomy reserve (open collector, active low)
15	Overload (open collector, active low)
5 - 6 - 8 - 9 - 10 - 11	<i>(do not connect)</i>

An example of how the open collector outputs can be used is given below:

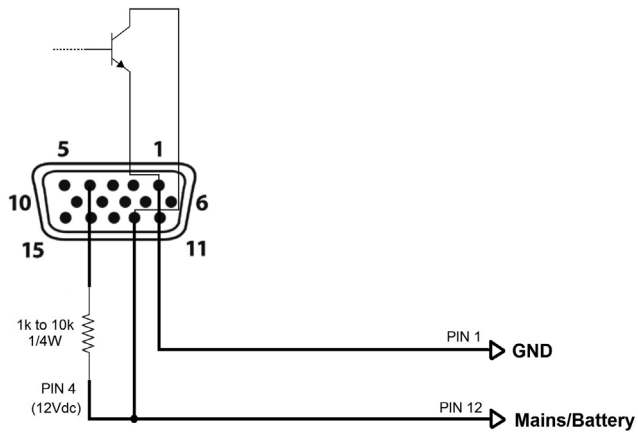

4.5.5 Network card (SNMP) slot

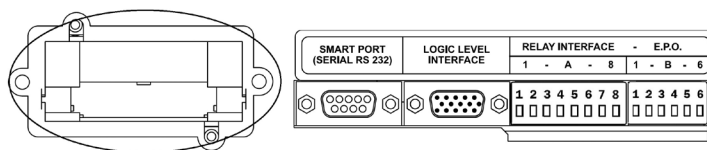

At the back of the UPS Trimod HE there is a slot for the SNMP card (optional).
The current taken from the SNMP slot for the functioning of the network card must be in total less than 700mA.

5. Configuration and Start-up



DANGER

All the configurations and start-up operations must be done only by a SKILLED TECHNICIAN (paragraph 2.2.1)

5.1 Introduction

This chapter contains all the information necessary for a correct configuration of the UPS and for its subsequent startup. The factory configuration provides for THREE PHASE INPUT and 120° THREE PHASE OUTPUT.

5.2 Input configuration

Trimod HE UPS automatically recognises the input voltage, frequency and number of phases if the electrical connection on the terminal strip is modified.



CAUTION

Make sure the neutral wire is always connected.

5.3 Output configuration

Trimod HE UPS does not automatically recognise the electrical configuration on the output terminal strip. For this reason it is always necessary to select the type of output voltage from the control panel according to the applied load.

The default configuration for the Trimod HE UPS is 120° three phase 400 Vac.

The UPS can also be configured to obtain a unique single output phase 230 Vac in the 10 kVA, 15 kVA, 20 kVA and 30 kVA TM models.

If the UPS is configured with three phase output, it is possible to select the management of the three phase as follows :

- THREE PHASES 120°: this is the default setup and is usually used if three phase loads are applied on the UPS output (e.g. three phase electrical motors) or if there are both three phase and single phase loads powered by the UPS. In this case the UPS manages the three output phases protecting the three phase load. For example, if an excessive load is applied to one of the three output lines, the automatic bypass switches all three output lines.
- THREE SINGLE PHASE OUTPUTS: this setup is necessary if three single phase lines have been created with the common neutral on the UPS output. In this case, the UPS manages the three outputs completely independently of each other. For example, if an excessive load is applied to one of the three output lines, the bypass intervenes only on the overloaded line while the power supply continues to be guaranteed on the other two by the UPS. If the input is single phase, the three lines are not in phase but rather with a phase shift of 120° and therefore cannot be connected in parallel. If the input is three phase, the outputs are in phase and the possibility of using the bypass is guaranteed.

For the correct selection of the output configuration, follow the instructions given in paragraph 5.5.

5.4 Pre-start-up checks

Before powering the equipment, carry out the following checks:

1. Check that the mains input switch S3 of the UPS is open (OFF position).
2. Check that the bypass input switch S5 of the UPS is open (OFF position).
3. Check that the battery fuse breakers of the UPS FB+ and FB- (if the model includes them) and those inside the external battery cabinet (if present) are open (OFF position).
For the Trimod HE 30TT in which the fuse breakers are installed in the terminal strip, check that all the battery drawers are not installed abutting and thus the string of batteries is interrupted.
4. Check that the maintenance bypass switch S1 and the output switch S2 of the UPS are open (OFF position)
5. Check that the wiring on input and output has been done and that all the connections have been tightened up properly.
6. Check the correct phase sequence of the mains input and bypass line (if separate).
7. Check that the parameters (voltage and frequency) of the input line are compatible with those shown on the UPS rating plate.
8. Check that all the power modules are inserted properly and that the fixing screws of the power modules are present and screwed up to abut the relative slots (use SHC M4x20 screws with hex socket head)
9. Check that all the battery drawers, if present, are inserted properly and that the fixing screws of the power modules are present and all the fixing screws are screwed up to abut (use SHC M4x20 screws with hex socket head)
In the case of the Trimod HE 30 TT, push the battery drawers one at a time to abut and screw them up with the fixing screws.

5. Configuration and Start-up

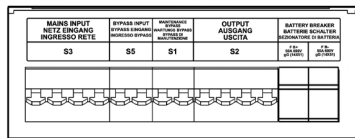

Trimod HE 10

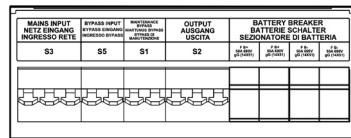

Trimod HE 15-20

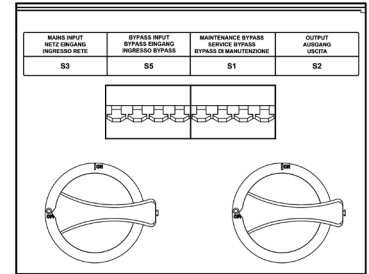

Trimod HE 30 TM

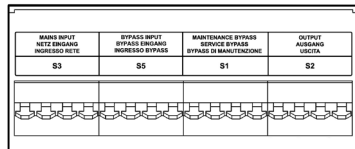

Trimod HE 30TT-40-60

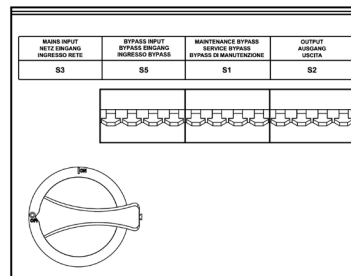

Trimod HE 80

5.5 Start-up procedure

1. Insert the battery fuses into the appropriate fuse breakers of the Trimod HE UPS if the model includes them and inside the external battery cabinets (if present).
2. Close the battery fuse breakers of the UPS and of the external battery cabinets FB+ and FB- (if present).



INDICATION

Before turning on the UPS it is necessary to select the correct output configuration (Single phase/ Three Phases 120° / Three independent phases). In order to do so, the rest of the procedure must be applied.

3. With the UPS off, press the ENTER key on the control panel and keep it held down until the text "Language" appears. Using the ARROW UP and ARROW DOWN keys, select the required language and confirm the choice with the ENTER key.
4. Press the ESC key to leave the Language page. The text "Service Mode" appears on the display. For further information about the function Service Mode and how the control panel works, consult the user manual.



CAUTION

Trimod HE is able to recognise the presence of non aligned firmware among the power modules and therefore prevent the start-up.

In Service Mode the status indicator flashes orange rapidly and the texts "Service Mode" and "PM FW not updated!" alternate.

Follow the path **Power Modules** → **PM SW update** to update the power module firmware. It is possible to choose **Update all PM** to check and if necessary update all the power modules, while with the option **Single PM SW update** you can select the specific power module to update.

5. Press the ENTER key to enter the menu. Using the ARROW UP and ARROW DOWN keys, it is possible to move the selection on the display; the ENTER key is used to confirm the choice and the ESC key is used to cancel the choice.

Follow the path **UPS Setup** → **Output** → **Inverter**

Select "Three Phases 120°" / "Three Phases indep." / "Single Phase" in accordance with the type of load and distribution downstream of the UPS.



CAUTION

The inverter output configuration must correspond with the configuration set on the output terminal strip during the installation.

Wrong connections or incorrect output configurations may cause injury and/or damage.

6. Follow the path **UPS Setup** → **Output** → **Voltage** and **UPS Setup** → **Output** → **Frequency** to check that the output voltage and output frequency are the ones required.

**CAUTION**

Trimod HE is configured as default with strings of batteries in common.

When installing independent strings of batteries, contact the LEGRAND Technical Support Service to obtain the installer password and the configuration instructions.

The type of battery installation is configured following the path **UPS Setup** → **Batteries** → **Common battery** after entering the password supplied by the LEGRAND Technical Support Service.

7. Follow the path **UPS Setup** → **Batteries** → **Total KB** to select the correct number of KB (Battery Kits) installed.

INDICATION

1 KB (Battery Kit) represents a string of 20 batteries in series.

In case of models with internal battery drawers and external modular battery cabinets, 1 KB comprises 4 battery drawers.

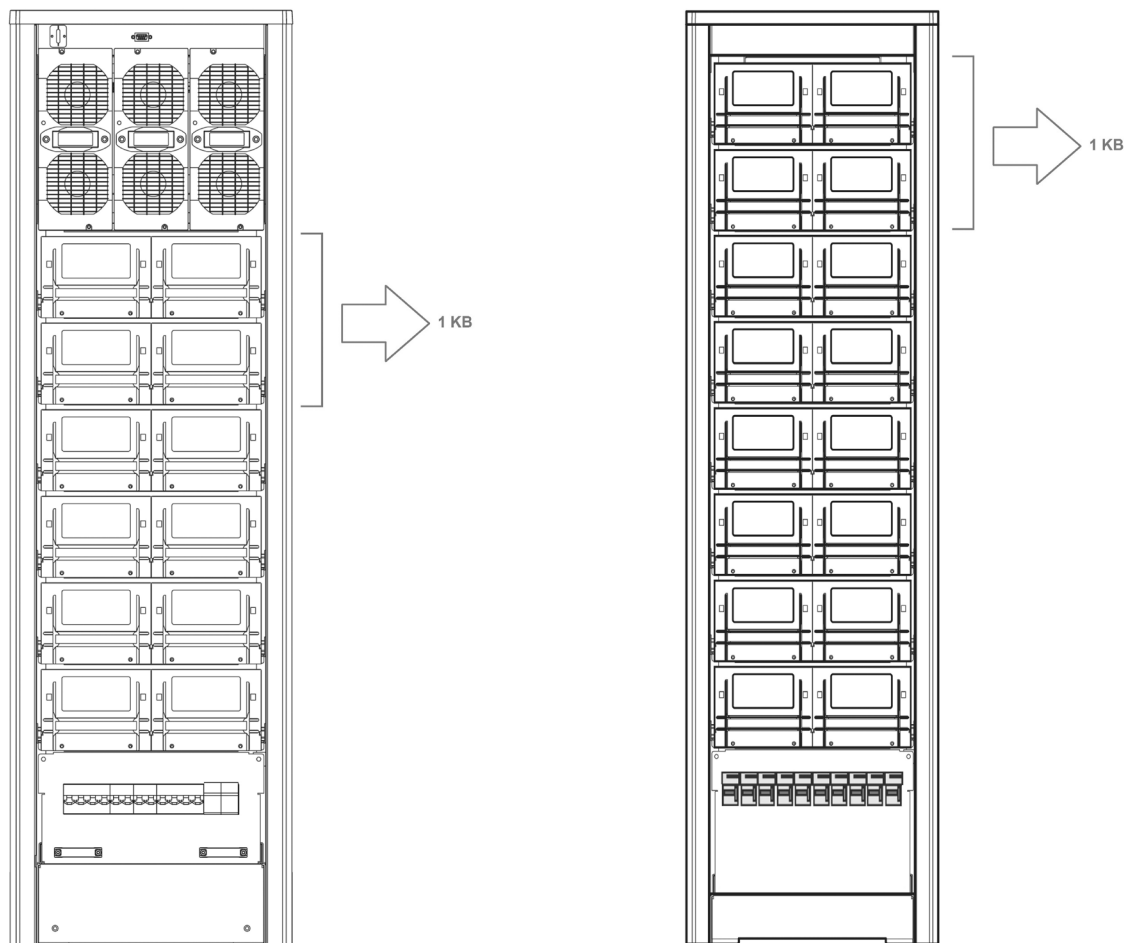

It is necessary to install 1 KB every 10 kVA of nominal UPS power in case of modular cabinets with battery drawers.

For example, for the Trimod HE 40 it is necessary to have at least one external modular battery cabinet with 4 KB (16 battery drawers).

In case of external non modular battery cabinets, each unit represents 1 KB and 1 KB is sufficient for all the Trimod HE models.

8. Follow the path **UPS Setup** → **Batteries** → **Capacity** to select the correct value of the capacity in Ah of the individual KB.

5. Configuration and Start-up

INDICATION

The UPS calculates the total battery capacity as produced by the total KB x Capacity.

9. Leave the Service Mode pressing the ON/OFF key.
10. Provide the power supply to the UPS and close the UPS mains input switch S3 and bypass input switch S5 (ON position).

INDICATION

If the "Standby Charge" is enabled, when the UPS is powered a battery charge cycle starts automatically. Press the ESC key to interrupt the standby charge and proceed with the power up of the UPS as described below.

11. Press the ON/OFF key to start up the UPS. When the display shows the text "<ENTER> to confirm UPS turn ON", press the ENTER key.



CAUTION

If the firmware of the power modules is out of alignment, the status indicator flashes red rapidly and the display shows the text "Invalid PM SW: ← to execute update".

Press the ENTER key to update the modules and complete the start up phase. Press the ESC key to interrupt the update and start-up procedures.

If no operation is carried out within 30 seconds, the UPS turns off.

12. Wait for the backlit status indicator on the control panel to show a steady green light.
13. Check that the output voltage and frequency values set correspond with the requirements of the applied load. If this is not the case, insert the values necessary (consult the user manual)
14. Close the output breaker S2 (position ON) of the UPS. At this point, the load is powered by the UPS.
15. Close the UPS door and remove the key.

INDICATION

If during the installation phase it is necessary to check the proper functioning of the UPS in battery mode, remove the mains by means of the breaker placed upstream of the UPS.



CAUTION

Do not remove the power modules during the functioning of the UPS without first having activated the proper procedure described in paragraph 6.4. The removal of one or more power modules without the proper procedure could damage the equipment.



CAUTION

The keys for opening the UPS door must not be left at the operator's disposal.



WARNING

The installation and maintenance manual and the quickstart sheet must not be left at the disposal of the operator.

5.6 ECO MODE setup

The UPS Trimod HE has a functioning mode called "eco mode", in which the load is supplied directly from the mains through the automatic bypass circuit inside the power modules.

If the output voltage leaves the window of tolerance (-20% / +15% of the set output voltage), the UPS actuates its inverter stage and supplies the load with the energy stored in the batteries.

When the input line is back within the tolerance values, the UPS is automatically taken back to the eco mode. It is possible to change the functioning mode between on-line and eco mode (and vice versa) both with UPS on and with the UPS off (through the Service mode).

To activate the eco mode, enter the main menu and follow the path **UPS Setup** → **Bypass** → **Off-line Mode**. Select "Enabled" and press the ENTER key to confirm the choice.

To return to the on-line mode, enter the main menu and follow the path **UPS Setup** → **Bypass** → **Off-line Mode**. Select "Disabled" and press the ENTER key to confirm the choice.

INDICATION

If the load needs to be supplied with a voltage without disturbances or with a voltage regulated in amplitude and/or frequency, it is necessary to use the UPS Trimod HE in on-line double conversion mode.

6. Maintenance



DANGER

INSTALLATION and ORDINARY MAINTENANCE operations must be carried out by SKILLED TECHNICIANS only (paragraph 2.2.1). EXTRAORDINARY MAINTENANCE operations must be carried out by LEGRAND TECHNICAL SUPPORT SERVICE only.

6.1 Introduction

This chapter contains all the information necessary for a skilled technician to correctly install and maintain the Trimod HE UPS.



DANGER

The operator is not authorized to carry out the activities listed in the installation and maintenance manual. LEGRAND declines all liability for any injury or damage caused by activities carried out differently from the instructions written in this manual or by a skilled technician who doesn't follow the requirements written in the installation and maintenance manual.

6.2 Preventive maintenance

The UPS does not contain parts for preventative maintenance by the operator.

The operator must periodically perform:

- a general external cleaning;
- a check to verify the absence of alarms on the display;
- a check to verify the correct functioning of the fans on each power module.

During a preventive maintenance inspection the skilled technician must carry out the following checks:

- no alarm presence;
- list of the memorised events;
- correct functioning of the static and maintenance bypass;
- integrity of the electrical installation;
- flow of cold air;
- battery status;
- characteristics of the applied load;
- conditions of the installation location.

After the first year of UPS life, check the batteries every six months through the "battery calibration" function to guarantee the optimal operation and continuous protection of the connected load. With this function, the UPS detects the discharge curve of the batteries in order to provide precise information on the charging state.

Enter the main menu to perform this operation and follow the path **Tools → Batteries → Batt. Calibration**

Press the ENTER key to confirm the choice.

Contact the LEGRAND Technical Support Service in case of problems.

6.3 Periodical checks

The correct functioning of the UPS must be guaranteed by periodical maintenance inspections. These are essential to safeguard its reliability.



WARNING

The periodical checks involve operations inside the equipment in presence of dangerous voltages. Only maintenance personnel trained by LEGRAND are authorized to work.

6.4 Ordinary maintenance

6.4.1 Power module hot-swap replacement or inclusion of new modules

Trimod HE EVO models from 30 kVA to 80 kVA (with two to four command boards) allow the hot-swap of the power modules in case of failure or for the inclusion of new modules. Thanks to this function the load is always powered by the UPS and not by the bypass line. The procedure requires the turning off of the modules that are managed by the same command board. The load is powered by the remaining power modules.

INDICATION

To use this function, it is necessary to have sized the UPS properly. If the percentage of the load does not allow the hot-swap without overload, perform the manual bypass mode maintenance procedure.

6. Maintenance

The command boards (CM) and the power modules (PM) are identified by a unique address inside the system, as shown below:

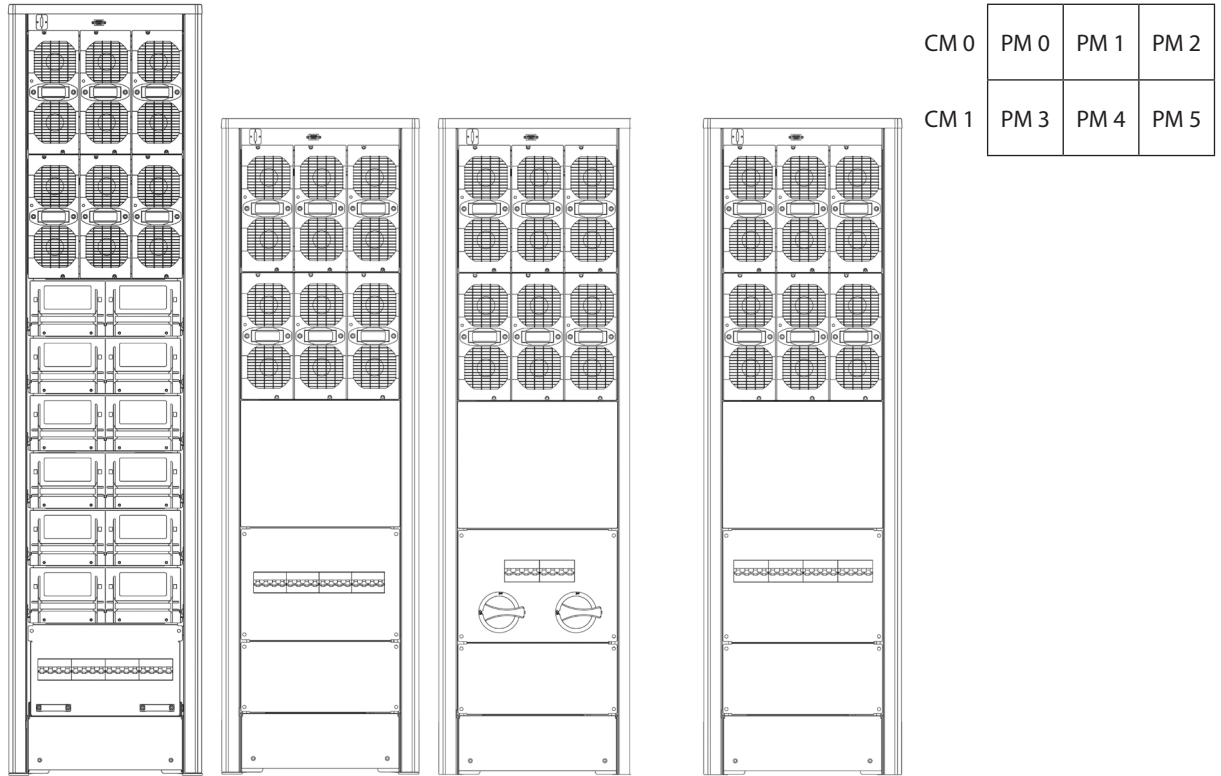

CM 0	PM 0	PM 1	PM 2
CM 1	PM 3	PM 4	PM 5

Trimod HE 30 TT/TM

Trimod HE 40

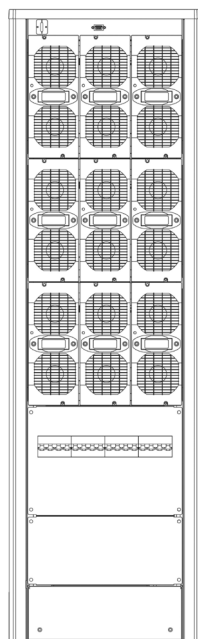

CM 0	PM 0	PM 1	PM 2
CM 1	PM 3	PM 4	PM 5
CM 2	PM 6	PM 7	PM 8

Trimod HE 60

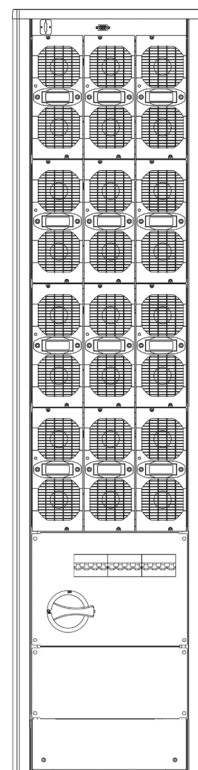

CM 0	PM 0	PM 1	PM 2
CM 1	PM 3	PM 4	PM 5
CM 2	PM 6	PM 7	PM 8
CM 3	PM 9	PM 10	PM 11

Trimod HE 80

Each command board (CM) controls three power modules (PM).

To change a power module, the three modules belonging to one command board are switched off. The maximum power available becomes 50% of the nominal power for Trimod HE 30 TT/TM and 40, 66% for Trimod HE 60 and 75% for Trimod HE 80.

Do the following to replace one or more faulty modules:

1. Check that the load percentage applied to the UPS allows the hot-swap replacement without overloading the UPS.
2. Open the door of the Trimod HE and identify the command board that controls the power module you want to replace.
3. Press the ON/OFF key briefly (less than 0.5 seconds)

INDICATION

By pressing the ON/OFF key for more than 2 seconds, the display shows the text "Turn off the UPS?" If this occurs, press the ESC key.

4. Press the ENTER key to access the **Hot swap** menu. Using the ARROW UP/DOWN keys, choose the control board (CM) on which to perform the hot-swap. The group of associated power modules that are turned off are identified by the fast flashing of the front led with red color.
5. Press the ENTER key. The command board selected turns off all the associated power modules and stays in standby mode.
6. Await the complete shutdown of the power modules (front led off and fans still).
7. Loosen the fixing screws of the power modules that you intend to replace and conserve them.
8. Take the power modules you intend to replace out one at a time.
9. Check on all the new power modules that the two leds visible through the two holes in the side cover are off. If they are on, wait till they turn off.
10. Insert the new power modules one at a time making sure that they are in abutment and fix them using the screws removed previously. The two fixing screws allow the module's earthing and must both be fixed for safety purposes.
11. Press the ON/OFF key briefly (less than 0.5 seconds)

INDICATION

By pressing of the ON/OFF key continuously for more than 2 seconds, the display shows the text "Turn off the UPS?" If this occurs, press the ESC key.

12. Press the ENTER key to access the **Hot swap** menu. Using the ARROW UP/DOWN keys, choose the control board (CM) indicated as being OFF and press the ENTER key. The command board automatically restarts all the associated power modules.
13. The progress bar ("CM initialize ") makes it possible to monitor the completion of the operation. At the end of the operations, the UPS returns to operate with all the power modules.
14. Close the UPS door (the keys must not be left at the operator's disposal).

INDICATION

The procedure for adding power modules is the same as the previous one. In step 7, remove the plastic masks of the kit 3 108 66 that cover the empty slots where you want to add new power modules.



CAUTION

Trimod HE is able to recognise the presence of non aligned firmware among the power modules and therefore prevent the start up.

If the firmware of the power modules is out of alignment, the status indicator flashes red rapidly and the display shows the text "Invalid PM SW Versions: ← to execute update".

Press the ENTER key to update the power modules and complete the exit from the hot-swap mode.

Press the ESC key or do not carry out any operation for thirty seconds to interrupt the exit procedure from the hot-swap mode. In this case the "Modules turned OFF" and "PM FW not updated!" texts alternate on the display and the status indicator flashes intermittent orange. To update the power modules, go into the **Hot swap** menu and turn on the command board that is off.

INDICATION

If one or more screws are lost, only use M4x20 SHC screws (socket hex head screws) to fix the power modules.

6. Maintenance

WARNING

Do not touch the backplane of the tunnel left uncovered for the removal of the power modules because there are dangerous live parts.

On the cover of the power module there are two holes from which it is possible to see two leds that signal the presence of dangerous voltage on the rear connection. Before performing any operation on the power module, make sure that these leds are off. If they are on, wait for them to go off.

If one or more power modules are not installed, the free slots must be covered by installing the plastic mask of the kit 3 108 66. The protection must be fixed with two SHC M4X20 screws.

6.4.2 Maintenance procedure of the UPS in maintenance bypass mode

If the power module hot-swap replacement procedure (paragraph 6.4.1) is not applicable, it is possible to make the replacement with the UPS in maintenance bypass mode.

This mode is also necessary to perform maintenance or replace parts such as command boards, backplanes, update the UPS firmware etc.

CAUTION

During forced and maintenance bypass operations, the load is not protected because it is supplied from the bypass input line.

CAUTION

The power modules may not be replaced without adhering scrupulously to the instructions below.

Accessing the manual maintenance bypass mode

1. Open the Trimod HE UPS door.
2. Enable the UPS in forced bypass mode by entering the menu **UPS Setup** → **Bypass** → **Forced Mode**
Set the value of the parameter to "Enable" with the ARROW UP/DOWN keys. Press the ENTER key to confirm.
In this condition the power modules are excluded and the load is powered directly from the mains. The display shows the text "Forced on Bypass". When the equipment is in forced bypass mode, the status indicator on the front of the panel flashes quickly. The leds on the power modules flash quickly as well.
3. Close the maintenance manual bypass switch (S1) bringing it to the ON position. The load is powered directly from the mains. The display shows the text "Maintenance Bypass".
4. Open the output disconnect switch (S2) bringing it to the OFF position.
5. Shutdown the UPS by holding the ON/OFF key down for a few seconds. When the display shows the text "Turn off the UPS?" press the ENTER key.
6. Open the mains input switch (S3) and bypass input switch (S5) bringing them to the OFF position.
7. Open the battery breakers of the UPS and all the external battery cabinets (if present).
8. Press the ON/OFF key to discharge any internal capacity. Then procede with the maintenance operations.

WARNING

In the case of models with internal batteries, some parts remain with dangerous voltage even after all the battery fuse breakers are opened. Remove at least one battery drawer for every shelf present in order to interrupt the battery string set.

WARNING

Inside the upper part of the UPS where the command boards and the relay contacts card are located there could be dangerous voltage due to the connection of the external backfeed control line. Be careful of connector EC9 of the relay contacts card to which the backfeed line is connected.

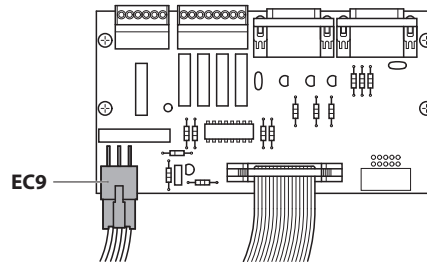

Note: by making the external backfeed protection as per the diagram in paragraph 4.2.6, it is possible to isolate the line from outside and make it safe.

Power module replacement or inclusion of new modules

1. Check that the procedure for setting the maintenance bypass mode described in the paragraph above has been applied.
2. Extract the power module after undoing the two fixing screws.

CAUTION

On the cover of the power module there are two holes from which it is possible to see two leds that signal the presence of dangerous voltage on the rear connector. Before performing any operation on the power module, make sure that these leds are off. If they are on, wait for them to turn off.

3. Check that the two leds visible through the two holes in the side cover of the new power module are off. If they are on, wait for them to turn off.
4. Insert the new power module in the same slot where the previous one was located.
5. Fix the new power module to the frame with the two screws provided along with the power module, making sure they abut. Use SHC M4x20 screws (hex socket head). The two fixing screws allow the power module's earthing and must both be fixed for safety purposes.

The procedure described does not need further manual setups from the control panel. The UPS automatically recognises the new power module and it is configured automatically.

INDICATION

The procedure for adding power modules is the same as the previous one. In step 2, remove the plastic masks of the kit 3 108 66 that cover the empty slots where you want to add new power modules.

Exiting from maintenance manual bypass

To transfer the UPS from the maintenance bypass status to the normal mode, do the following:

1. Check that the output switch (S2) is open (OFF position).
2. Close the battery breakers of the UPS and of all the external battery cabinets (if present).
In the case of models with internal batteries, also reinsert the removed battery drawers to reconnect the battery string series.
3. Close the mains input switch (S3) and bypass input switch (S5) bringing them to the ON position.
4. Press the ON/OFF key to start up the UPS. When the display shows the text "<ENTER> to confirm UPS turn ON", press the ENTER key.

CAUTION

Trimod HE is able to detect the presence of a firmware mismatch among the power modules and therefore to prevent the turning on.

If the firmware of the power modules is out of alignment, the status indicator flashes red rapidly and the display shows the text "Invalid PM SW Versions:  to execute update".

Press the ENTER key to update the modules and complete the start up phase. Press the ESC key to interrupt the update and start-up procedures.

If no operation is carried out within 30 seconds, the UPS turns off.

6. Maintenance

5. Wait until the start-up procedure is completed. The main screen is shown on the display. Under this condition the load is powered directly by the bypass line. The display shows together the texts "Manual Bypass" and "Forced on Bypass". The backlit indicator shines orange.
6. Open the output disconnecter switch (S2) bringing it to the ON position.
7. Open the maintenance manual bypass switch (S1) bringing it to the OFF position.
8. Enable the UPS in normal mode. Enter in the main menu and follow the path **UPS Setup → Bypass → Forced Mode**. Set the value of the parameter to "Disabled" with the ARROW UP/DOWN keys. Press the ENTER key to confirm.
9. At the end of the procedure the UPS works normally. Under these conditions the backlit indicator shines green.
10. Close the Trimod HE UPS door (the keys must not be left at the operator's disposal).

6.4.3 Maintenance procedure with UPS off



CAUTION

The shut down procedure must only be applied if the load connected to the UPS is off or does not need powering.

1. Keep the ON/OFF key pressed for at least two seconds.
2. When the display shows the text "Turn off the UPS?", press the ENTER key.
3. Wait for the shut down operation to complete.
4. Open the output disconnecter switch (S2) bringing it to the OFF position.
5. Open the mains input switch (S3) and bypass input switch (S5) bringing them to the OFF position.
6. Open the battery breakers of the UPS and of all the external battery cabinets (if present).
7. Press the ON/OFF key to discharge any internal capacity.
8. Open the breaker upstream of the UPS that supplies power from the mains. Once these operations have been carried out, the UPS is without voltage. It is possible to proceed with the maintenance operations.



WARNING

Inside the upper part of the UPS where the command boards and the contact interface card are located there could be dangerous voltage due to the connection of the external backfeed control line. Be careful of connector EC9 of the contact interface card to which the backfeed line is connected.

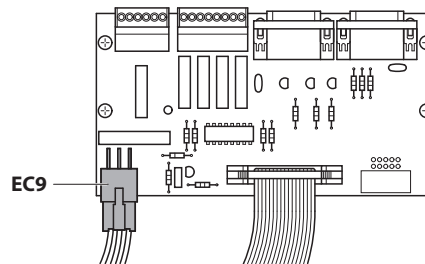

Note: by making the external backfeed protection as per the diagram in paragraph 4.2.6, it is possible to isolate the line from the outside and make it safe.

6.5 Battery drawers requirements

The battery drawers of the UPS and modular Trimod HE BATTERY can be installed/replaced in two different ways in addition to the one with the UPS off described in paragraph 6.4.3.

INDICATION

The battery drawers must always be added/removed in multiples of 4 (1 KB consists of four battery drawers for models with internal battery or external modular battery cabinets). If a KB is added, start from the free slots at the bottom and covered with the plastic covers of the kit 3 108 65. If a KB is completely removed, cover the free slots with the empty battery slot covers of the kit 3 108 65.

If the installation/removal procedure changes the total number of KB installed in the UPS, it is necessary to update this setting from the control panel.

After concluding the installation/replacement operations, calibrate the batteries through the control panel to get precise indications regarding the total autonomy of the UPS.

To perform this operation, enter the main menu and follow the path **Tools → Batteries → Batt. Calibration**.

Press the ENTER key to confirm the choice.

INDICATION

Always replace only 1 KB at a time

6.5.1 Installation/replacement of battery drawers with UPS in normal mode

If the UPS has more than 1 KB every 10kVA of power supplied on the output, it is possible to replace 4 battery drawers (1 KB) a time with the UPS functioning in normal mode.

This operation can be carried out on models with internal batteries and on modular Trimod HE BATTERY.

The replacement procedure is the following:

1. Check that the UPS has installed more than 1KB every 10kVA of power supplied.
2. Check that the UPS is not functioning in battery mode and that the battery charger is in the "maintenance" or "standby" state.
To check the status of the battery charger, go into the menu **UPS Status → Measures → Batteries** and check the fourth item shown on the screen.
3. Extract the four battery drawers relative to just one KB. To add another KB, do not remove any battery drawer.
4. Insert the four new battery drawers and fix them with the screws provided with them.
5. Repeat steps 2, 3 and 4 for every KB to install/replace.

INDICATION

If the UPS switches to battery mode during the operation, do not extract nor insert battery drawers. It is possible to resume the operation when the UPS returns to normal mode.

If during the operation the input mains power fails, the autonomy is reduced: it is therefore necessary to carefully assess this circumstance in relation to the application before starting the procedure.

6.5.2 Installation/replacement of battery drawers with UPS in maintenance manual bypass

This procedure is valid for both models with internal batteries and for modular Trimod HE BATTERY.

1. Check that the procedure for placing in maintenance bypass mode described in the paragraph 6.4.2 has been applied.
2. Extract the four battery drawers relative to just one KB. To add another KB, do not remove any battery drawer.
3. Insert the four new battery drawers and fix them with the screws provided.
4. Repeat steps 2 and 3 for every KB to install/replace.
5. To leave the manual maintenance status actuate the procedure described in paragraph 6.4.2.

**CAUTION**

During maintenance bypass operations, the load is not protected because it is supplied from the bypass input line.

6.6 Extraordinary maintenance

Contact the LEGRAND Technical Support Service if there are failures that require the access to internal parts of the UPS.

7. Warehousing



All storage operations must be carried out only by a **SKILLED TECHNICIAN** (paragraph 2.2.1)



A SKILLED TECHNICIAN must check that there is no voltage present before disconnecting the cables. All the battery breakers on the UPS and on the external battery cabinets must be open. The battery drawers of the Trimod HE MODULAR BATTERY (if present) and of the UPS (according to the model) must be removed.

7.1 UPS

The UPS must be stored in an environment with a room temperature between -20°C (-4°F) and +50°C (+122°F) and humidity less than 90% (not condensing).

7.2 Batteries

It is possible to store batteries without recharging them in the following conditions:

- up to 6 months if the temperature is between +20°C (+68°F) and +30°C (+86°F);
- up to 3 months if the temperature is between +30°C (+86°F) and +40°C (+104°F);
- up to 2 months if the temperature is over +40°C (+104°F).



The battery drawers or the external battery cabinets must never be stored if the batteries are partially or totally discharged. LEGRAND is not liable for any damage or bad functioning caused to the UPS by wrong warehousing of the batteries.

8. Dismantling



DANGER

Dismantling and disposal operations must be carried out only by a **SKILLED TECHNICIAN** (paragraph 2.2.1). The instructions in this chapter are to be considered indicative: in every country there are different regulations with regard to the disposal of electronic or hazardous waste such as batteries. It is necessary to strictly adhere to the standards in force in the country where the equipment is used. Do not throw any component of the equipment in the ordinary rubbish.

8.1 Battery disposal

Batteries must be disposed of in a site intended for the recovery of toxic waste. Disposal in the traditional rubbish is not allowed.

Apply to the competent agencies in your country for the proper procedure.



Pb



WARNING

A battery may constitute a risk of an electric shock and high short-circuit current.

When working on batteries, the prescriptions indicated in chapter 2 must be adhered to.

8.2 UPS dismantling

The dismantling of the UPS must occur after the dismantling of the various parts it consists of.

For the dismantling operations, it is necessary to wear the Personal Protective Equipment mentioned in paragraph 2.3 and to consult the instructions and diagrams in the installation and maintenance manual.

Sub-divide the components separating the metal from the plastic, from the copper and so on according to the type of selective waste disposal in the country where the machine is dismantled.

If the dismantled components must be stored before their disposal, be careful to keep them in a safe place protected from atmospheric agents to avoid soil and groundwater contamination.

8.3 Electronic component dismantling

For the disposal of electronic waste like the control panel or the command boards it is necessary to refer to the relevant standards.



This symbol indicates that in order to prevent any negative effects on the environment and on people, this product should be disposed of separately from other household waste, by taking it to authorised collection centres, in accordance with the EU countries local waste disposal legislations. Disposing of the product without following local regulations may be punished by law. It is recommended to check that this equipment subject to WEEE legislations in the country where it is used.

9. Technical data

Main features

	3 103 96 3 103 97 3 104 02 3 104 22 3 104 31 3 104 42 3 104 43 3 104 44 10 kVA	3 104 03 3 104 07 3 104 08 3 104 23 3 104 33 3 104 45 3 104 46 15 kVA	3 104 09 3 104 13 3 104 14 3 104 23 3 104 32 3 104 33 3 104 47 3 104 48 20 kVA	3 104 25 3 104 68 30 kVA TM	3 104 15 3 104 17 3 104 18 3 104 24 3 104 34 3 104 69 30 kVA TT	3 104 19 3 104 26 3 104 71 40 kVA	3 104 20 3 104 27 3 104 72 60 kVA	3 104 73 80 kVA
Nominal power	10 kVA	15 kVA	20 kVA	30 kVA	30 kVA	40 kVA	60 kVA	80 kVA
Active Power	10 kW	15 kW	20 kW	30 kW	30 kW	40 kW	60 kW	80 kW
Technology	online, double conversion Classification according to EN62040-3: VFI-SS-111							
IN/OUT Configuration	Single-phase / Single-phase Single-phase / Three-phase Three-phase / Single-phase Three-phase / Three-phase (may be configured by a skilled technician)				Three-phase / Three-phase			
Dual Input	Available on all models							
Command boards	1			2 for the MULTI CTRL model (3 104 68-69-71)		3 for the MULTI CTRL model (3 104 72)	4	
UPS architecture	Modular with power modules PF=1 Expandable, redundant N+X							
Neutral system	Neutral passing straight from input to output (not isolated)							
Bypass	Automatic (static and electromechanical) Manual (for maintenance)							

Input electrical characteristics

	3 103 96 3 103 97 3 104 02 3 104 22 3 104 31 3 104 42 3 104 43 3 104 44 10 kVA	3 104 03 3 104 07 3 104 08 3 104 23 3 104 33 3 104 45 3 104 46 15 kVA	3 104 09 3 104 13 3 104 14 3 104 23 3 104 32 3 104 33 3 104 47 3 104 48 20 kVA	3 104 25 3 104 68 30 kVA TM	3 104 15 3 104 17 3 104 18 3 104 24 3 104 34 3 104 69 30 kVA TT	3 104 19 3 104 26 3 104 71 40 kVA	3 104 20 3 104 27 3 104 72 60 kVA	3 104 73 80 kVA
Maximum three-phase/ three-phase current	19.2 A	28.8 A	38.4 A	57.6 A	57.6 A	76.8 A	115.2 A	153.6 A
Maximum three-phase/ single-phase current	19.2 A	28.8 A	38.4 A	57.6 A	-	-	-	-
Maximum single-phase/ three-phase current	57.6 A	86.4 A	115.2 A	172.8 A	-	-	-	-
Maximum single-phase/ single-phase current	57.6 A	86.4 A	115.2 A	172.8 A	-	-	-	-
Nominal input voltage	230 V + 15% - 20% (Single-phase) 400 V + 15% - 20% (Three-phase) (neutral line indispensable)				400 V + 15% - 20% (Three-phase) (neutral line indispensable)			
Input frequency	50 / 60 Hz ± 2% 50 / 60 Hz ± 14 % (autosensing and/or selectable by the user)							
Power factor on input	> 0.99							
Total harmonic distortion of the input current	THDi < 3%							

Electrical output characteristics (normal mode)

	3 103 96 3 103 97 3 104 02 3 104 22 3 104 31 3 104 42 3 104 43 3 104 44	3 104 03 3 104 07 3 104 08 3 104 23 3 104 33 3 104 45 3 104 46	3 104 09 3 104 13 3 104 14 3 104 23 3 104 32 3 104 33 3 104 47 3 104 48	3 104 25 3 104 68	3 104 15 3 104 17 3 104 18 3 104 24 3 104 34 3 104 69	3 104 19 3 104 26 3 104 71	3 104 20 3 104 27 3 104 72	3 104 73
	10 kVA	15 kVA	20 kVA	30 kVA TM	30 kVA TT	40 kVA	60 kVA	80 kVA
Maximum three-phase/ three-phase current	14.5 A	21.7 A	29 A	43.5 A	43.5 A	58 A	87 A	116 A
Maximum three-phase/ single-phase current	43.5 A	65.2 A	87 A	130.5 A	-	-	-	-
Maximum single-phase/ three-phase current	14.5 A	21.7 A	29 A	43.5 A	-	-	-	-
Maximum single-phase/ single-phase current	43.5 A	65.2 A	87 A	130.5 A	-	-	-	-
Nominal output voltage	230 V ± 1% (Single-phase) 400 V ± 1% (Three-phase)				400 V ± 1% (Three-phase)			
Nominal output frequency	50 / 60 Hz							
Tolerance on the output frequency	If synchronised with the input frequency: adjustable range from ±1% to ±14% If not synchronised: ± 1%							
Crest factor admitted on the output current	3:1							
Efficiency (AC/AC on-line)	up to 96%							
Efficiency ECO mode	99% max							
Overload admitted	115% for 10 minutes without automatic bypass intervention 135% for 60 seconds without automatic bypass intervention							

Electrical output characteristics (battery mode)

	3 103 96 3 103 97 3 104 02 3 104 22 3 104 31 3 104 42 3 104 43 3 104 44	3 104 03 3 104 07 3 104 08 3 104 23 3 104 33 3 104 45 3 104 46	3 104 09 3 104 13 3 104 14 3 104 23 3 104 32 3 104 33 3 104 47 3 104 48	3 104 25 3 104 68	3 104 15 3 104 17 3 104 18 3 104 24 3 104 34 3 104 69	3 104 19 3 104 26 3 104 71	3 104 20 3 104 27 3 104 72	3 104 73
	10 kVA	15 kVA	20 kVA	30 kVA TM	30 kVA TT	40 kVA	60 kVA	80 kVA
Nominal output voltage	230 V ± 1% (Single-phase) 400 V ± 1% (Three-phase)				400 V ± 1% (Three-phase)			
Output frequency	50 / 60 Hz ± 1%							
Total harmonic distortion of output voltage on non- linear nominal load	< 1%							
Overload admitted	115% for 2 minutes 135% for 30 seconds							

9. Technical data

Batteries and Battery Charger Characteristics

	3 103 96 3 103 97 3 104 02 3 104 22 3 104 31 3 104 42 3 104 43 3 104 44	3 104 03 3 104 07 3 104 08 3 104 23 3 104 33 3 104 45 3 104 46	3 104 09 3 104 13 3 104 14 3 104 23 3 104 32 3 104 33 3 104 47 3 104 48	3 104 25 3 104 68	3 104 15 3 104 17 3 104 18 3 104 24 3 104 34 3 104 69	3 104 19 3 104 26 3 104 71	3 104 20 3 104 27 3 104 72	3 104 73
	10 kVA	15 kVA	20 kVA	30 kVA TM	30 kVA TT	40 kVA	60 kVA	80 kVA
Battery type	Lead-acid sealed without maintenance (VRLA)							
Unitary capacity	Battery drawers for UPS or external modular battery cabinets: 12 Vdc 7.2Ah or 12 Vdc 9 Ah							
Rated battery voltage	240 Vdc (20 x 12 Vdc batteries in series)							
Type of battery charger	High performance PWM, one for each power module							
Recharge curve	Smart Charge, advanced three-stage cycle							
Nominal recharge current battery charger	2.5 A max for every power module installed							

Features

	3 103 96 3 103 97 3 104 02 3 104 22 3 104 31 3 104 42 3 104 43 3 104 44	3 104 03 3 104 07 3 104 08 3 104 23 3 104 33 3 104 45 3 104 46	3 104 09 3 104 13 3 104 14 3 104 23 3 104 32 3 104 33 3 104 47 3 104 48	3 104 25 3 104 68	3 104 15 3 104 17 3 104 18 3 104 24 3 104 34 3 104 69	3 104 19 3 104 26 3 104 71	3 104 20 3 104 27 3 104 72	3 104 73
	10 kVA	15 kVA	20 kVA	30 kVA TM	30 kVA TT	40 kVA	60 kVA	80 kVA
Signals and alarms	Large four line alphanumeric screen, multicolour status indicator, acoustic notification							
Communications ports	2 x RS 232 ports, 1 relay interface, 1 contact port, 1 SMNP module slot							
Software	<p>Free software for the Windows and Linux environments is available which expands the functions of:</p> <ul style="list-style-type: none"> - displaying all the functioning and diagnostic data in case of problems; - setup of special functions; - automatic shutdown of all the computers supplied by the UPS (if connected to TCP/IP network) <p>Visit us at http://www.ups.legrand.com to download a copy of the software free of charge.</p>							
Protections	<p>Electronics against overloads, short-circuit and excessive battery discharge</p> <p>Block of functions due to the end of autonomy</p> <p>In-rush limiter on start up</p> <p>E.P.O. contact</p> <p>Auxiliary contact for Backfeed protection</p>							

Mechanical characteristics

	Empty power cabinets						
	3 104 22	3 104 23	3 104 23	3 104 68 3 104 25	3 104 24	3 104 71 3 104 26	3 104 72 3 104 27
	10 kVA	15 kVA	20 kVA	30 kVA TM	30 kVA TT	40 kVA	60 kVA
Net weight (kg)	85	90	90	85	80	82	91
Dimensions w x h x d (mm)	414 x 1367 x 628						
Power modules (PM4) 3400VA to be installed	3	-	-	-	-	-	-
Power modules (PM6) 5000VA to be installed	-	3	-	6	6	-	-
Power modules (PM7) 6700VA to be installed	-	-	3	-	-	6	9
Power module net weight (kg)	8,5						
Battery drawer net weight (kg)	13		-	-	-	-	-

	Empty power cabinets					
	3 104 31	3 104 33	3 104 32	3 104 33	3 104 34 3 104 69	3 104 73
	10 kVA	15 kVA	20 kVA	20 kVA	30 kVA TT	80 kVA
Net weight (kg)	98	102	102	102	106	120
Dimensions w x h x d (mm)	414 x 1650 x 628					
Power modules (PM4) 3400VA to be installed	3	-	6	-	-	-
Power modules (PM6) 5000VA to be installed	-	3	-	-	6	-
Power modules (PM7) 6700VA to be installed	-	-	-	3	-	12
Power module net weight (kg)	8,5					
Battery drawer net weight (kg)	13					-

9. Technical data

Mechanical characteristics

	Power cabinets with PM					
	3 103 96	3 104 08	3 104 14	3 104 18	3 104 19	3 104 20
	10 kVA	15 kVA	20 kVA	30 kVA TT	40 kVA	60 kVA
Net weight (kg)	120	120	120	146	146	165
Dimensions w x h x d (mm)	414 x 1367 x 628					
Power modules (PM4) 3400VA installed	3	-	-	-	-	-
Power modules (PM6) 5000VA installed	-	3	-	6	-	-
Power modules (PM7) 6700VA installed	-	-	3	-	6	9
Power module net weight (kg)	8,5					
Battery drawer net weight (kg)	13			-	-	-

	Power cabinets with PM			
	3 103 97	3 104 03	3 104 09	3 104 15
	10 kVA	15 kVA	20 kVA	30 kVA TT
Net weight (kg)	155	155	155	181
Dimensions w x h x d (mm)	414 x 1650 x 628			
Power modules (PM4) 3400VA installed	3	-	-	-
Power modules (PM6) 5000VA installed	-	3	-	6
Power modules (PM7) 6700VA installed	-	-	3	-
Power module net weight (kg)	8,5			
Battery drawer net weight (kg)	13			

Mechanical characteristics

	UPS (PM + batteries)						
	3 104 42	3 104 43	3 104 44	3 104 45	3 104 46	3 104 47	3 104 48
	10 kVA	10 kVA	10 kVA	15 kVA	15 kVA	20 kVA	20 kVA
Net weight (kg)	167	223	279	220	279	220	279
Dimensions w x h x d (mm)	414 x 1367 x 628						
Power modules (PM4) 3400VA installed	3	3	3	-	-	-	-
Power modules (PM6) 5000VA installed	-	-	-	3	3	-	-
Power modules (PM7) 6700VA installed	-	-	-	-	-	3	3

	UPS (PM + batteries)			
	3 104 02	3 104 07	3 104 13	3 104 17
	10 kVA	15 kVA	20 kVA	30 kVA TT
Net weight (kg)	350	350	350	325
Dimensions w x h x d (mm)	414 x 1650 x 628			
Power modules (PM4) 3400VA installed	3	-	-	-
Power modules (PM6) 5000VA installed	-	3	-	6
Power modules (PM7) 6700VA installed	-	-	3	-

9. Technical data

Environmental conditions

	3 103 96 3 103 97 3 104 02 3 104 22 3 104 31 3 104 42 3 104 43 3 104 44	3 104 03 3 104 07 3 104 08 3 104 23 3 104 33 3 104 45 3 104 46	3 104 09 3 104 13 3 104 14 3 104 23 3 104 32 3 104 33 3 104 47 3 104 48	3 104 25 3 104 68	3 104 15 3 104 17 3 104 18 3 104 24 3 104 34 3 104 69	3 104 19 3 104 26 3 104 71	3 104 20 3 104 27 3 104 72	3 104 73
	10 kVA	15 kVA	20 kVA	30 kVA TM	30 kVA TT	40 kVA	60 kVA	80 kVA
Operating temperature	0 ÷ 40 °C							
Relative humidity during operation	0% ÷ 95% non condensing							
Storage temperature	-20°C ÷ 50 °C (excluding batteries)							
Noise level at 1 metre	58 ÷ 62 dBA							
Pollution degree	PD2							
Environmental category (EN 6021-3-3)	3K2							
Protection Index	IP 20							
Operating height	up to 1000 metres above sea level without derating							

Trimod HE 3 108 51 battery charger module (BCM) technical specifications

Nominal input voltage	230 Vac + 15% - 20%
Nominal input current	19.3 A
Input power factor	PF > 0.99
Total harmonic distortion of the input current	THDi < 3%
Nominal output voltage	240/252 Vdc
Output voltage in maintenance phase	13.75 Vdc per battery
Nominal input current	15 Adc max
AC/DC performance	>93% at max rated output current
Functioning status indications (signalled by multicoloured LED on module and indications on UPS display)	<p>Yellow LED, fast flashing: recharge phase f1</p> <p>Green LED, slow flashing: recharge phase and maintenance f2</p> <p>Green LED steady: standby</p> <p>Red LED: fault status</p>

Reference directive and standards

Marks	CE, EAC, CMIM
Safety	2014/35/EU Directive EN 62040-1
EMC	2014/30/EU Directive EN 62040-2
Performance and test requirements	EN 62040-3

10. Tables



CAUTION

The choice of the type and section of the connecting wires depending on their voltage, rated current and installation must be done as indicated in the standards in force in the country where the UPS is installed and it is a responsibility of the installation engineer.

The input current and the output power of the UPS are indicated in chapter 9 and the battery current in table 8 of this chapter.

The following tables give an indication of the wire cross sections to use if the wires are unipolar with simple PVC installation and installation in tube in the air.

TABLE 1

Minimum wire cross sections recommended for UPS Trimod HE

POWER	INPUT PHASES	OUTPUT PHASES	INPUT CABLE	BYPASS CABLE (in case of separate bypass line)	OUTPUT CABLE
10 kVA	3	3	5 x 4 mm ²	5 x 4 mm ²	5 x 4 mm ²
	1	1	3 x 10 mm ²	3 x 10 mm ²	3 x 10 mm ²
	1	3	3 x 10 mm ²	3 x 10 mm ²	5 x 4 mm ²
	3	1	5 x 10 mm ²	5 x 10 mm ²	3 x 10 mm ²
15/20 kVA	3	3	5 x 10 mm ²	5 x 10 mm ²	5 x 10 mm ²
	1	1	3 x 25 mm ²	3 x 25 mm ²	3 x 25 mm ²
	1	3	3 x 25 mm ²	3 x 25 mm ²	5 x 10 mm ²
	3	1	5 x 25 mm ²	5 x 25 mm ²	3 x 25 mm ²
30 kVA TM	3	3	5 x 16 mm ²	5 x 16 mm ²	5 x 16 mm ²
	1	1	3 x 50 mm ²	3 x 50 mm ²	3 x 50 mm ²
	1	3	3 x 50 mm ²	3 x 50 mm ²	5 x 16 mm ²
	3	1	5 x 50 mm ²	5 x 50 mm ²	3 x 50 mm ²
30 kVA TT	3	3	5 x 16 mm ²	5 x 16 mm ²	5 x 16 mm ²
40 kVA	3	3	5 x 25 mm ²	5 x 25 mm ²	5 x 25 mm ²
60 kVA	3	3	5 x 35 mm ²	5 x 35 mm ²	5 x 35 mm ²
80 kVA	3	3	5 x 50 mm ²	5 x 50 mm ²	5 x 50 mm ²

INDICATION

The maximum cable cross section that can be installed in the terminals is 50 for mm² all the models.

TABLE 2

Battery fuse values recommended for UPS Trimod HE with internal batteries

POWER	BATTERY FUSES	
	UPS Trimod HE	
	F B+	F B-
10/15/20 kVA	50A 400V gG (14 x 51 mm)	50A 400V gG (14 x 51 mm)
30 kVA TT	160A 500V gG (SIZE 00)	160A 500V gG (SIZE 00)

10. Tables

TABLE 3

Battery fuse values recommended for MODULAR Trimod HE BATTERY 4KB

POWER	BATTERY FUSES	
	MODULAR Trimod HE BATTERY 4 KB (16 drawers)	
	F B+	F B-
10/15/20/30 kVA	n°4 – 50A 500V gG (14 x 51 mm)	n°4 – 50A 500V gG (14 x 51 mm)

TABLE 4

Battery fuse values recommended for MODULAR Trimod HE BATTERY 5KB

POWER	BATTERY FUSES	
	MODULAR Trimod HE BATTERY 5KB (20 drawers)	
	F B+	F B-
10/15/20/30/40/60 kVA	n°5 – 50A 500V gG (14 x 51 mm)	n°5 – 50A 500V gG (14 x 51 mm)

TABLE 5

Battery fuse values recommended for external NON MODULAR battery cabinets 1KB (94Ah)

POWER	BATTERY FUSES	
	external NON MODULAR battery cabinets 1KB (94Ah)	
	F B+	F B-
10 kVA	No. 1 – 50A 500V gG (22 x 58 mm)	No. 1 – 50A 500V gG (22 x 58 mm)
15/20 kVA	No. 1 – 100A 500V gG (22 x 58 mm)	No. 1 – 100A 500V gG (22 x 58 mm)
30 kVA TT/TM	No. 2 – 80A 500V gG (22 x 58 mm)	No. 2 – 80A 500V gG (22 x 58 mm)
40 kVA	No. 2 – 125A 500V gG (22 x 58 mm)	No. 2 – 125A 500V gG (22 x 58 mm)
60 kVA	No. 3 – 100A 500V gG (22 x 58 mm)	No. 3 – 100A 500V gG (22 x 58 mm)
80 kVA	No. 4 – 100A 500V gG (22 x 58 mm)	No. 4 – 100A 500V gG (22 x 58 mm)

TABLE 6
Automatic breaker recommended for mains input and bypass line

POWER	INPUT PHASES	OUTPUT PHASES	AUTOMATIC CIRCUIT BREAKER RECOMMENDED
10 kVA	3	3	C curve 20A (3P+N)
	3	1	C curve 63A (3P+N)
	1	1-3	C curve 63A (1P+N)
15kVA	3	3	C curve 32A (3P+N)
	3	1	C curve 100A (3P+N)
	1	1-3	C curve 100A (1P+N)
20 kVA	3	3	C curve 40A (3P+N)
	3	1	C curve 100A (3P+N)
	1	1-3	C curve 100A (1P+N)
30 kVA TM	3	3	C curve 63A (3P+N)
	3	1	C curve 160A (3P+N)
	1	1-3	C curve 160A (1P+N)
30 kVA TT	3	3	C curve 63A (3P+N)
40 kVA	3	3	C curve 80A (3P+N)
60 kVA	3	3	C curve 100A (3P+N)
80 kVA	3	3	C curve 150A (3P+N)

TABLE 7
Residual current breaker recommended for mains input and bypass line

POWER	RESIDUAL CURRENT BREAKER RESIDUAL CURRENT ($I_{\Delta n}$)
10 kVA	≥ 300 mA B type
15 kVA	
20 kVA	
30 kVA TT/TM	
40 kVA	
60 kVA	
80 kVA	

10. Tables

TABLE 8

Maximum current absorbed by the batteries at 100% of the load and minimum wire cross sections recommended for connection of the UPS to the external battery cabinets.

POWER	MAXIMUM BATTERY CURRENT	MINIMUM WIRE CROSS SECTION RECOMMENDED
10 kVA	50 A	1 x 10 mm ² for each pole
15 kVA	76 A	1 x 16 mm ² for each pole
20 kVA	100 A	1 x 25 mm ² for each pole
30 kVA TT/TM	152 A	2 x 25 mm ² for each pole
40 kVA	202 A	2 x 35 mm ² for each pole
60 kVA	304 A	2 x 50 mm ² for each pole
80 kVA	405 A	2 x 70 mm ² for each pole

11. Wiring diagrams

11.1 Block diagram of interconnections and distributions of the UPS cabinet

The following figure shows the block diagram of a Trimod HE 60 distribution. The layout is similar for all the other models. The bypass input terminals are represented according to the factory configuration (bypass input line in common).

CABINET DISTRIBUTION

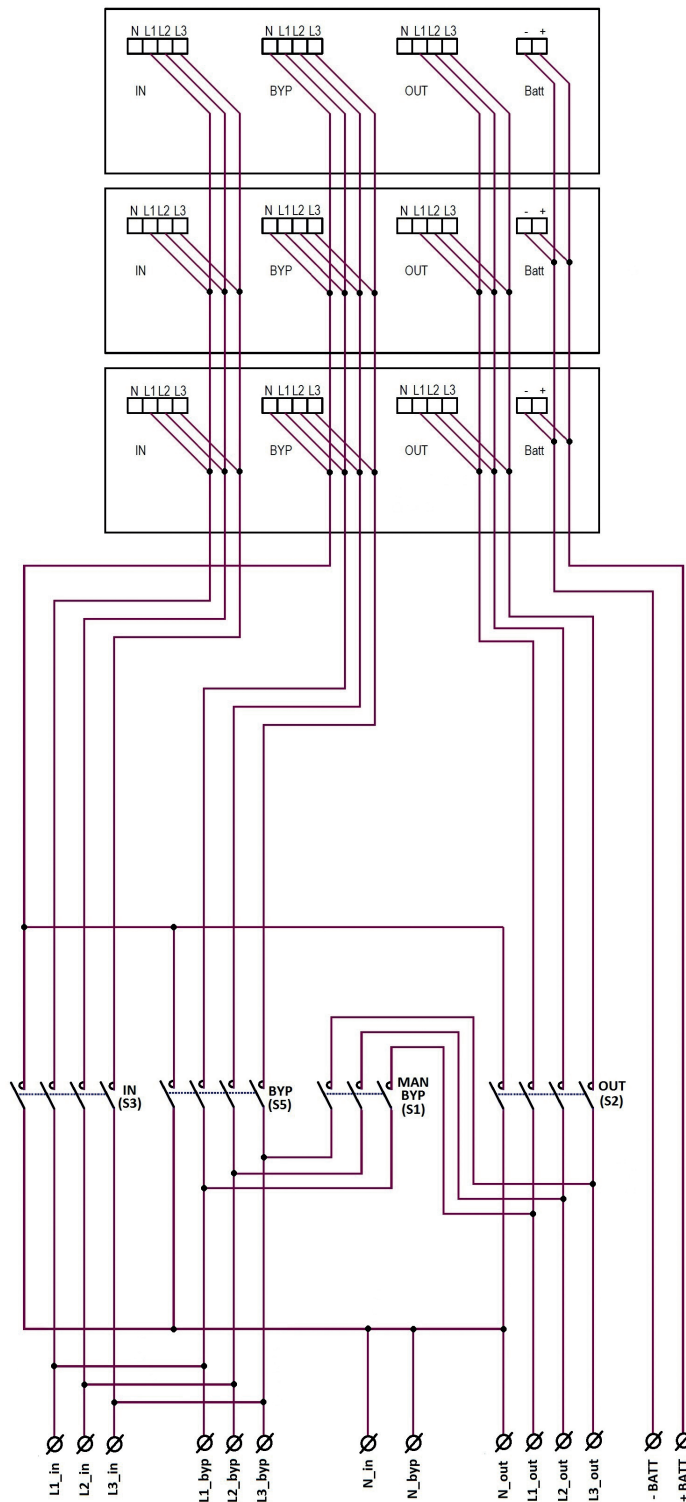

LEGRAND
Pro and Consumer Service
BP 30076 - 87002
LIMOGES CEDEX FRANCE
www.legrand.com

┌ Installer stamp ───────────┐

└───────────────────────────┘